

PROGRAM OVERVIEW

PLASTIC ENCLOSURES
ALUMINUM ENCLOSURES
TUNING KNOBS
ACCESSORIES





“ENCLOSURES ARE MORE THAN JUST PACKAGING FOR THE ELECTRONICS!”

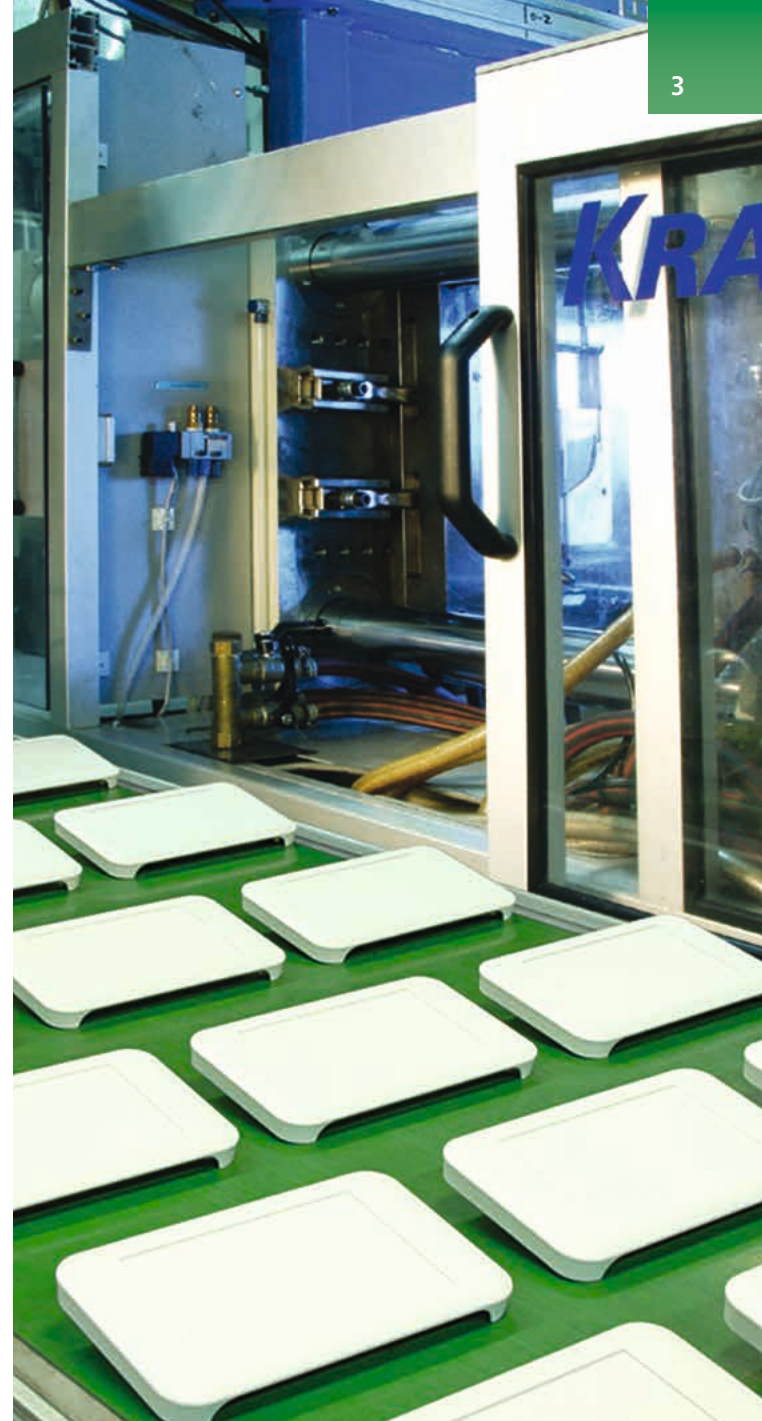

WELCOME TO OKW

OUR PHILOSOPHY

Enclosures are more than just packaging. They give your product its face, they offer functions and their design is convincing. We support you with all of our standards, our knowledge and our individualization options.

This gives you your very own electronic package that will maintain its value and meet all of your customers' requirements – for the sustained success of your device.

YOUR COMPETENT PARTNER

We have been setting creative standards since 1954. OKW and tuning knobs are terms that have gone down in history. In 1972 we presented the flat-pack case, the first standard enclosure made of plastic for the electronics industry.

Our approx. 100 committed workers as well as the Schneider family of entrepreneurs are proud of what they have achieved: a sound family-owned business which is now in its 3rd generation, a range of its own – made in Germany – with almost 3,000 articles in stock, a global logistics network,

all conceivable technologies available in-house to individualize your products, and numerous design awards.

And where we ourselves cannot be present, we have our subsidiaries in 8 countries on 3 continents, our long-standing sales partners and of course reputed distributors working throughout the world for you, one of more than 25.000 customers of ours.

The management system we have introduced complies with the standard DIN EN ISO 9001 (DQS).

PLASTIC ENCLOSURES



TUNING KNOBS

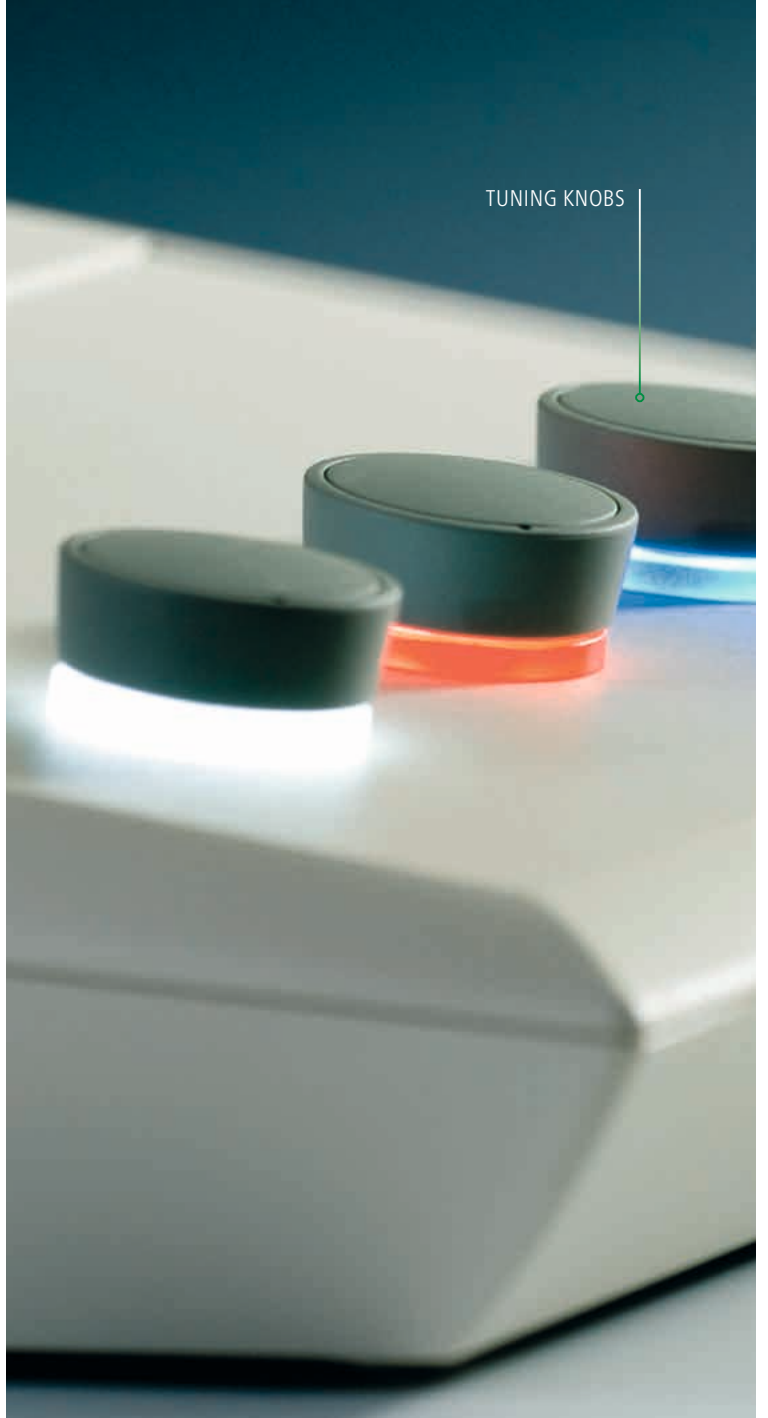

“ENCLOSURES, TUNING KNOBS
AND SERVICES FOR YOUR
INDIVIDUAL APPLICATION.”



ALUMINUM/
PLASTIC ENCLOSURES



MODIFICATIONS AND FINISHING
SPECIAL SIZES

BESPOKE ENCLOSURES &
TUNING KNOBS

CONTENTS

2 INTRODUCTION

6 OVERVIEW
PLASTIC & ALUMINUM ENCLOSURES

8 OVERVIEW
ACCESSORIES FOR ENCLOSURES, TUNING KNOBS

10 OVERVIEW
MODIFICATIONS, BESPOKE CASES

12 OVERVIEW
ENCLOSURES FOR YOUR APPLICATIONS

16 PLASTIC & ALUMINUM ENCLOSURES

103 ACCESSORIES FOR ENCLOSURES

110 TUNING KNOBS

122 MODIFICATIONS & FINISHING

133 SPECIAL SIZES

134 BESPOKE ENCLOSURES & TUNING KNOBS

138 OKW WEBSITE



OKW ENCLOSURES ARE INCOMPARABLE IN DESIGN AND, THANKS TO THEIR SOPHISTICATED TECHNICAL FEATURES, ARE THE IDEAL SOLUTION FOR COMFORT-ORIENTED USERS WHO ARE LOOKING FOR SOMETHING SPECIAL.

“INNOVATIVE TECHNOLOGY AND AESTHETIC DESIGN FOR ADVANCED EQUIPMENT.”

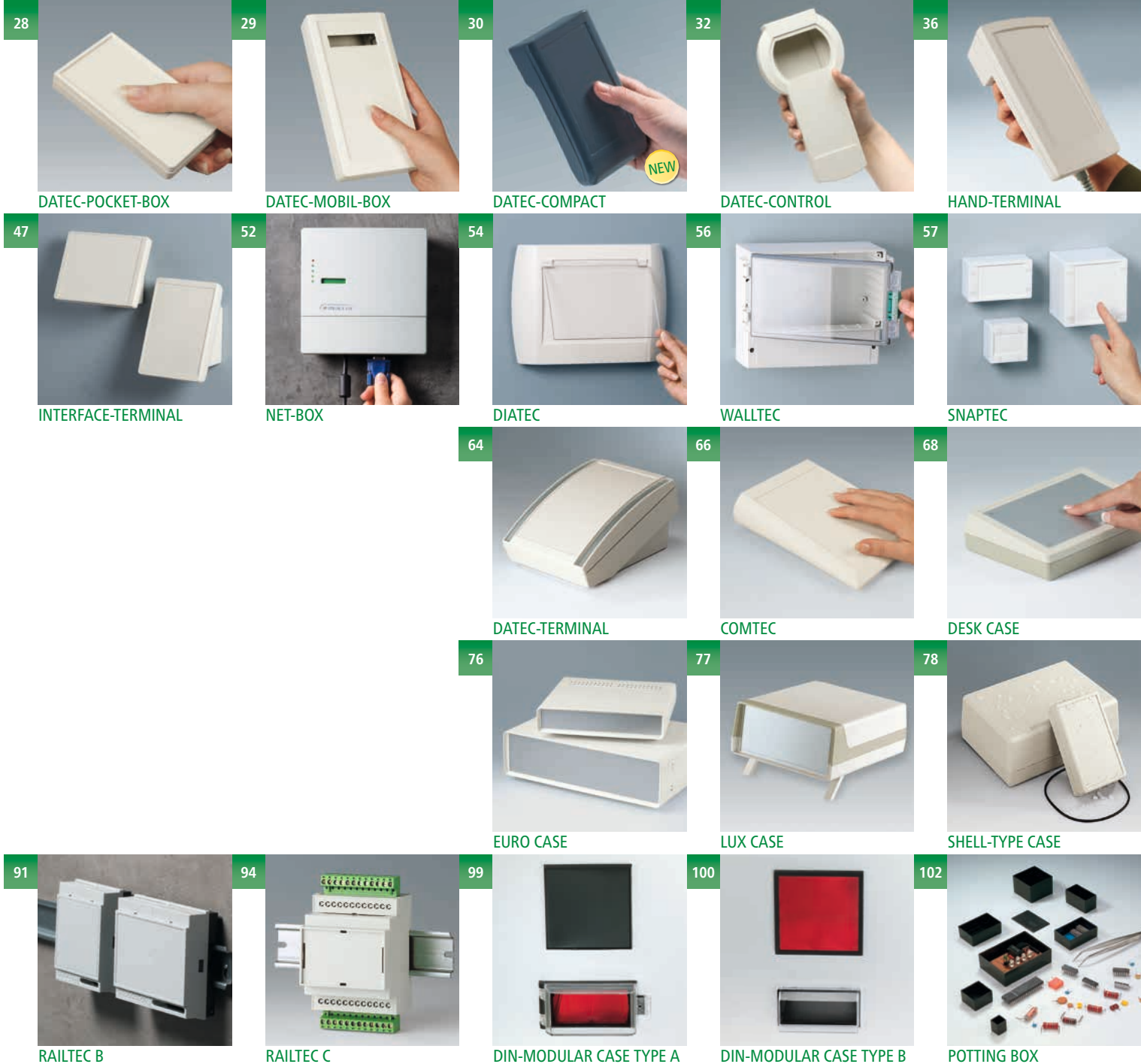

PLASTIC AND ALUMINUM ENCLOSURES

THE FINE DETAILS

When it is a question of impressing customers through reliability, ergonomics and attractiveness, the standard enclosures by OKW offer all advantages.

Our comprehensive range of products offers different types, sizes and versions. This makes it possible for us to present to you the whole variety of our system.

THE RIGHT CHOICE

Innovative technology and aesthetic forms for attractive device design.

System components specially geared to application scenarios.

Compatible with standardised displays, batteries, membrane keyboards, terminal blocks, plug headers, Eurocards, DIN rails, switch panel cutouts and much more.

Robust, installation-friendly design.

Excellent surface quality.

High-quality materials to match the applications in question.

Functional range of accessories for individual configuration.

Made in Germany.



103

WALL MOUNTING



103

HOLDING DEVICES



105

TILT FOOT BARS/HANDLE BARS, BRACKETS



105

CARRYING ACCESSORIES



107

CABLE GLANDS



BATTERY COMPARTMENTS AND HOLDERS, BUTTON CELL HOLDERS



106

PRESSURE COMPENSATION ELEMENTS



107

USB COVERS



107

CONTACTS, CONNECTIONS



108

EMC PRODUCTS



109

SCREWS, SOCKETS, SPACERS

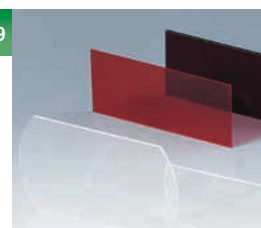

108

DISPLAY WINDOWS



108

ADHESIVE FOILS



108

PLASTIC AND ALUMINUM PANELS

ACCESSORIES FOR ENCLOSURES

“INNOVATIVE TECHNOLOGY AND AESTHETIC DESIGN FOR ADVANCED EQUIPMENT.”

114



STAR-KNOBS
"SURFACE-MOUNTED"

112



STAR-KNOBS
"FLUSH-FITTING"

116



TOP-KNOBS

117



COM-KNOBS

118



COMBINATION KNOBS

120



TUNING KNOBS

TUNING KNOBS

ACCESSORIES FOR ENCLOSURES

OKW offers a comprehensive range of accessories which can be used to adapt our enclosures to many different applications and provide additional useful functions.

Besides our standard accessories, we can also supply individual blanks for display windows and front panels, adhesive foils and sealings. We can also offer a wide range of fasteners, e.g. threaded bushes and bolts, spacers, attachment domes, screws etc.

TUNING KNOBS

OKW Gehäuseysteme has over 60 years' experience in the development and production of tuning knobs. Today we can offer a wide range of modern and traditional tuning knob designs.

Our latest tuning knobs combine special technical features with a contemporary appearance. This includes optional LED illumination, flush-fitting installation, a main body which is slightly inclined towards the internal axis, function-oriented marking elements, modern color selection etc.

The OKW range of tuning knobs is well tried and tested for rotary potentiometers with round and flattened shaft ends in accordance with DIN 41591 or 6/4.6 mm. The knobs are fitted using the tried and tested collet fixture, lateral screw fixing or simply by pushing them on. Depending on requirements, there are different types of knob: round knobs, wing knobs, spindle-shaped knobs, pointer knobs or simple rotary switches.

Different sizes and combinations offer a wide range of possible solutions.



126

MACHINING



126

DISPLAY WINDOWS,
ADHESIVE FOILS & PANELS



127

EMC ALUMINUM
COATING



128

LACQUERING,
SURFACE COATING



128

WATER TRANSFER
PRINTING



SCREEN/TAMPO
PRINTING



129

DIGITAL PRINTING
PARTS



129

DIGITAL PRINTING
LABELS



130

MEMBRANE KEYBOARDS



130

INSTALLATION / ASSEMBLY
OF ACCESSORIES



132

SPECIAL MATERIAL
"INDIVIDUAL COLORS"



132

SPECIAL MATERIAL
"FLAME-RETARDANT V-0"



132

SPECIAL MATERIAL
"BIO-PLASTIC"



133

SPECIAL SIZES

MODIFICATIONS, FINISHING & SPECIAL SIZES

"ENCLOSURE SOLUTIONS
CREATED TO MEET YOUR VERY
OWN INDIVIDUAL WISHES."



COMBINATION OF STANDARD AND CUSTOMER DESIGN



COMBINATION OF STANDARD AND CUSTOMER DESIGN



COMBINATION OF STANDARD AND CUSTOMER DESIGN



INDIVIDUAL DESIGN



COMBINATION OF STANDARD AND CUSTOMER DESIGN



INDIVIDUAL DESIGN



COMBINATION OF STANDARD AND CUSTOMER DESIGN



INDIVIDUAL DESIGN



COMBINATION OF STANDARD AND CUSTOMER DESIGN



INDIVIDUAL DESIGN



MATERIAL BLEND
PLASTIC & ALUMINUM



BESPOKE ENCLOSURES & TUNING KNOBS

MODIFICATIONS & FINISHING

Look at our comprehensive standard range and select the product that best matches your design ideas, your components and the needs of your customers.

Then, simply tell us what you need to complete your product design in our housing. Together we will agree the necessary modifications - ideal in terms of price, quality and delivery time - to meet your specifications.

Processing and finishing techniques see pages 124-131.

SPECIAL MATERIAL

Depending on requirements and intended use, we can produce the enclosures in special colors, in flame-resistant material or in an environment-friendly bio-plastic. See Page 132.

SPECIAL SIZES

We can develop your customer-specific enclosure size on the basis of the standard design. With the help of existing 3D models, we can design practically any special size to meet your needs and requirements. See page 133.

BESPOKE ENCLOSURES AND TUNING KNOBS

And what if your requirements go beyond our standard range of services? No problem. 35 years of experience in the development of enclosures is on hand to help you realize your own individual product.

From conception or development to series-type production, we can offer you the solution you need, for any quantity.

See pages 134-137.

Enclosures from A – Z	Product application						
	DIN rail enclosures	Flush mounting enclosures	Enclosures for suspension arm systems	Potting boxes	Handheld enclosures	Wearable enclosures	
ART-CASE							
BLOB							
BODY-CASE							
CARRYTEC							
COMTEC							
CONNECT							
DATEC-COMPACT							
DATEC-CONTROL							
DATEC-MOBIL-BOX							
DATEC-POCKET-BOX							
DATEC-TERMINAL							
DESK CASES							
DIATEC							
DIN-MODULAR CASE TYPE A							
DIN-MODULAR CASE TYPE B							
ERGO-CASE							
EURO CASE							
FLAT-PACK CASE							
HAND-HELD-BOXES							
HAND-TERMINAL							
IN-BOX							
INTERFACE-TERMINAL							
LUX CASE							
MEDITEC							
MINITEC							
MOTEC							
NET-BOX							
PLUG CASES							
POTTING BOX							
RAILTEC B							
RAILTEC C							
ROBUST-BOX							
SENSO-CASE							
SHELL-TYPE CASES							
SMART-BOX							
SMART-CASE							
SNAPTEC							
SOFT-CASE							
SYNERGY							
TOPTEC							
UNITEC							
WALLTEC							



INTERFACE-TERMINAL – Bottom enclosure part, front panel with tablet cutout and brackets, curved station made of aluminum.

CARRYTEC – Unique enclosure with integrated handle, large operating panel and plenty of room for interfaces.

SOFT-CASE with individual touch screen.

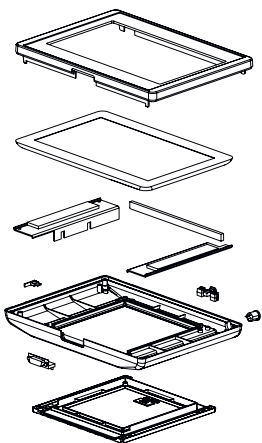

“MODERN SOLUTIONS
FOR STANDARD-TABLETS
AND INDIVIDUAL TOUCH
SCREENS.”



Aluminum front panel for the installation of the iPad Air in the INTERFACE-TERMINAL series of enclosures.



Top part made of ABS in the color of the enclosure.

CARRYTEC with cutout for the iPad Air.



PACKAGING FOR TABLET COMPUTERS / TOUCH SCREENS

VISUALIZATION & DATA TRANSFER

In industrial equipment, tablets are more and more frequently assuming the functions of visualization and data transfer. But how can you combine company-specific know-how in measurement and control engineering with the features of a tablet, reliably, elegantly and attractively? On the basis of our standard range, we can offer you many different options for integrating both elements in a modern enclosure.

The installation of individual touch screens is also possible.

CUSTOMER-SPECIFIC SOLUTIONS

The following enclosures are highly suitable for the installation of standard tablet computers and individual touch screens:

INTERFACE-TERMINAL (P. 47-51)

With **aluminum front panel** with a polished, anodised surface finish. This reflects the high-quality appearance of the installed solution.

Or with the **top part made of ABS (UL 94 HB)** in the enclosure color of off-white (RAL 9002).

Three sizes: 6.4" (16 cm), 8.4" (21 cm) and 10.4" (26 cm).

CARRYTEC (P. 38-41)

Enclosure with handle in the colors off-white (RAL 9002) or lava.

Three sizes: 8.4" (21 cm), 10.4" (26 cm) and 13.4" (34 cm).

For small enclosures for the installation of touch screens, see also our website link "Advanced Search" > Display size.

On request we can also make the necessary cutouts for tablet computers and individual touch screens for you. Installation is effected from behind, outside the field of vision.





AESTHETIC DESIGN & EXCELLENT QUALITY

“ENCLOSURES MADE
OF PLASTIC AND
ALUMINUM.”



SMALL ENCLOSURE WITH FLAIR

THE PRODUCT

BODY-CASE is the new “wearable” enclosure standard from OKW.

The enclosure design is perfect for so-called “wearable technologies”: on your arm, around your neck, in shirt and trouser pockets or loose in an article of clothing.

The BODY-CASE fulfils its function in the simplest way, without restricting the user in his or her activities and without being conspicuous.

YOUR ADVANTAGE

Modern appearance with highly polished surfaces and a matt TPE sealing ring.

Components and sensors that are worn on the body or close to the body can thus be accommodated elegantly and practically in a small space.

Simple and individual differentiation through the use of standard commercial watch straps (18 mm wide). Spring bar tool for fitting / removing the spring bars available as an accessory.

MATERIAL / COLOR

Plastic parts:

- ASA (UL 94 HB), traffic white (RAL 9016)

Sealing ring:

- TPE, vermilion (RAL 2002)
- TPE, lava

PROTECTION CLASS IP 65 / 67

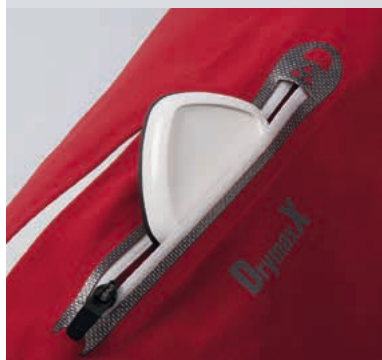

COMFORTABLE TO WEAR ON THE BODY

OUTSIDE DIM. IN INCHES

2.165" x 1.811" x 0.669" (L x W x H)

APPLICATIONS

Mobile data recording and data transmission, tracking and monitoring equipment, emergency call and notification systems as well as bio-feedback sensors in the fields of health care, medical technology, leisure and sports.

Also in industry, for example safety engineering, communications technology, stock and sales logging, measuring and control technology. Ideal for jobs where safety and permanent localisation are required.

YOUR ADVANTAGE

The aesthetic design supports the positive perception of the device, thus increasing user loyalty to the product.

Easy operation with the help of pushbuttons or touchscreens, at the press of a button and with the help of voice commands or gestures.

Internal power supply with round or button cells which are mounted directly on the PCB – alternatively, the use of a rechargeable battery with copper loop for charging the device inductively (see example on our website).

YOUR ADVANTAGE

Top part with / without recessed surface for the protection of a decor foil or membrane keypad.

Wireless networking.

Optional accessories:
wrist strap, fastening kit (clip, eyelet),
spring bar tool,
lanyard and
hand strap.

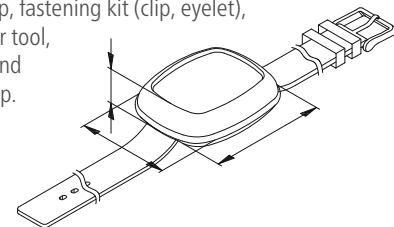



product
design
award

2009



Designpreis
Deutschland

NOMINEE



PRACTICAL MOBILE CASE DESIGN

THE PRODUCT

The new MINITEC cases convince users with their mini-dimensions and maxi-benefits.

Whether round your neck or round your wrist, MINITEC cases are your loyal companions and are always within easy reach. They are so small and light that they also fit into any trouser pocket.

Whether with orange, green, blue or volcano-colored intermediate rings or one colored, these MINITEC cases are the right enclosures for today's personal electronics.

ENCLOSURE DESIGN

You have a choice between an organic "MINITEC DROP" shape or a more technical "MINITEC EDGE" design.

Different intermediate rings and accessories offer the necessary flexibility for individual use.

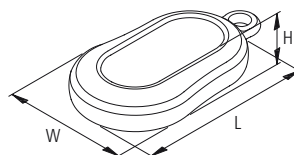

MATERIAL / COLOR

Bottom part / Top part:

- ABS (UL 94 HB), off-white (RAL 9002)
- ABS (UL 94 HB), lava
- PMMA*, black (RAL 9005)

Intermediate ring:

- TPE, lava
- TPE, orange
- TPE, green
- TPE, blue
- PMMA*, black (RAL 9005)
- TPE, off-white (RAL 9002)
- TPE, volcano
- ABS (UL 94 HB), black (RAL 9005)

PMMA (plexiglass)



THE PERFECT COMPANION

OUTSIDE DIM. IN INCHES

MINITEC	L x W x H
DROP S	2.008 x 1.260 x 0.512
DROP M	2.756 x 1.732 x 0.630
DROP L	3.307 x 2.087 x 0.748
EDGE S	2.047 x 1.260 x 0.591
EDGE M	2.677 x 1.654 x 0.709
EDGE L	2.677 x 1.654 x 0.945
	3.071 x 1.890 x 0.787
	3.071 x 1.890 x 0.945
	3.071 x 1.890 x 1.024

PROTECTION CLASS IP 41

MINITEC DROP (sizes S and M) with intermediate ring in TPE.

MINITEC EDGE (size M) with intermediate ring in TPE.

YOUR ADVANTAGES

Modern, flat styling.

Easy to wear, e.g. round your neck, or as a bracelet with wrist strap, on a key ring or on a belt (EL).

TPE ring for a pleasant touch sensation and as impact protection.

Also available in infra-red light-permeable material.

Recessed operating area for the protection of the membrane keypad or decorative foil. MINITEC Edge also without recessed operating area.

APPLICATIONS

Many different types of remote control systems.

Mobile USB solutions. Data logger stick.

Specially made for clinic and social fields as well as in the household and in industry, e.g. emergency systems, monitoring and alarm equipment, radio remote control etc.

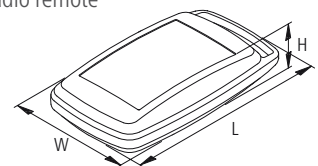

For ordering information, drawings and 3D models visit www.okwenclosures.com



GOOD TO HOLD

THE PRODUCT

The idea of giving greater expression to ergonomic requirements was the starting point of the development of the SMART-CASE.

And so the design follows the touch sensation of the human being, thus facilitating natural sequences of hand movements.

Benefit from the outstanding balance between design and technical sophistication.

YOUR ADVANTAGES

Convincing ergonomics; unique design.

Ideal for remote controls, with cables or with a battery compartment.

Cable glands for sizes M, L and XL for cables \varnothing 0.134" - 0.232". Cable gland already included.

MATERIAL / COLOR

Enclosure:

- ABS (UL 94 HB), off-white (RAL 9002)
- ABS (UL 94 HB), black (RAL 9005)
- PMMA*, black (RAL 9005)

Cable gland:

- TPE, volcano
- TPE, black

*PMMA (plexiglass®)



APPLICATION PERFECTED

OUTSIDE DIM. IN INCHES

SMART-CASE	L x W x H
XS	2.283 x 1.402 x 0.748
M	3.780 x 1.850 x 0.945
L	5.512 x 2.469 x 1.201
XL	6.614 x 2.929 x 1.394

PROTECTION CLASS IP 65

Sizes L and XL with optional seal and without battery compartment.

YOUR ADVANTAGES

Optionally in material permeable to infra-red signals from stock. For utmost efficiency the front face is polished.

Recessed operating area to protect the membrane keypad (M/L/XL).

Fastening pillars and fixing supports for PCBs and components.

Comprehensive range of accessories.

APPLICATIONS

Remote controls of all types, wireless or with cable connection.

Especially suitable for use in hospitals and social fields as well as in industry and households.

Measurement and control engineering.

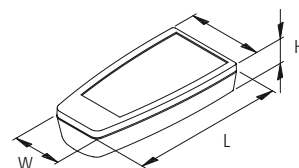



MODELLED FOR YOUR HAND

THE PRODUCT

Inspired by the touch sensation, the design is entirely geared to the needs of the user.

The BLOB enclosure innovation surprises the user with an unheard-of wealth of potential applications and a truly sensuous 3D touch sensation.

The hands of the user intuitively "grasp" the functions of the enclosure. The fingers almost automatically find individual ways of holding the product naturally, guiding it exactly and operating it with a minimum amount of effort.

YOUR ADVANTAGES

Attractive, sophisticated product design for a perfect, secure grip.

High level of practical value thanks to a convincing touch sensation.

Simple, intuitive use.

Gentle and at the same time rugged.

High surface finish quality.

Recessed operating area for the protection of the membrane keypad.

MATERIAL / COLOR

Enclosure:

■ ABS (UL 94 HB), off-white (RAL 9002)

■ ABS (UL 94 HB), lava

Cable gland:

■ TPE, volcano

OUTSIDE DIM. IN INCHES

BLOB	L x W x H
UNIT	5.118 x 2.362 x 1.181
CONTROL	4.488 x 2.992 x 1.220
PANEL	7.874 x 6.496 x 1.417

PROTECTION CLASS IP 54

With sealing (accessories).

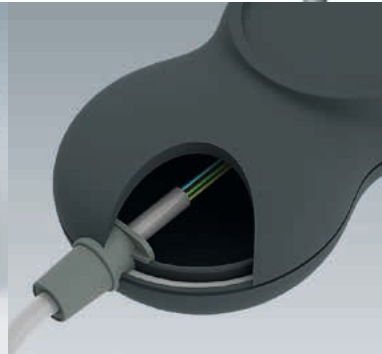

UNIVERSAL DESIGN

BLOB
UNIT

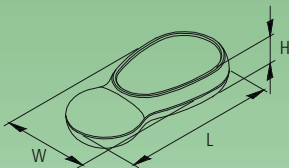

BLOB
CONTROL

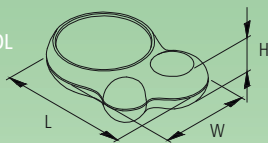

BLOB
PANEL

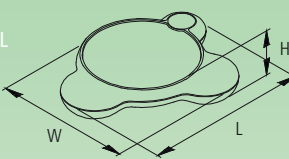

POWER SUPPLY

Cable glands (accessories) serve to protect the cable from kinking and form an attractive closing point. The entire circumference on the shadow groove of the enclosure is available for positioning a cable entry. For installation, a cylindrical hole is necessary.

An internal power supply can be effected using round or button cells. Battery clips and button cell holders that are mounted directly on the PCB are available in the standard range of accessories.

APPLICATIONS

Following the principles of "Universal Design", BLOB supports applications that are flexible enough to meet the needs of a large number of people with different hand sizes and grasping volumes.

Many different kinds of user-oriented applications, wireless or with cable. As self-sufficient or complementary units, or in a network with other units.

Ideal for diagnostics, therapy, laboratory, industry, office, household and leisure time.

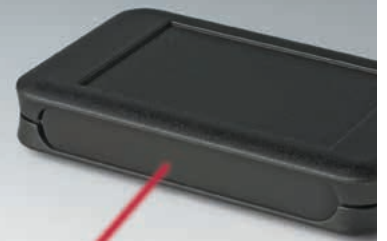

IN WIDE FORMAT

THE PRODUCT

The first pocket size case with "wide-format" design. From now on, larger displays can thus be accommodated in a user-friendly small space. The case design makes it easy not only to read off the display but also to operate the unit.

The intermediate ring represents a further innovation in the SOFT-CASE. Different colors and materials allow individual designs and interesting combinations.

YOUR ADVANTAGES

User-friendly design. Ideal for miniaturised electronics developments.

The unique "wide format" offers a generous interface area as well as sufficient room for larger displays.

Intermediate rings (accessories) ensure more installation height; TPE version serves as a sealing ring and impact protection device for protection class IP 54 (enclosures without battery compartment only).

MATERIAL / COLOR

Enclosure:

- ABS (UL 94 HB), off-white (RAL 9002)
- BIOGRADE®, off-white (RAL 9002)
- ABS (UL 94 HB), lava
- PMMA*, black (RAL 9005)

Intermediate ring:

- ABS (UL 94 HB), off-white (RAL 9002)
- BIOGRADE®, off-white (RAL 9002)
- ABS (UL 94 HB), lava
- TPE, volcano
- PMMA*, black (RAL 9005)

*PMMA (plexiglass®)



SYSTEM VARIETY

OUTSIDE DIM. IN INCHES

SOFT-CASE	W x L x H
S	3.228 x 2.008 x 0.551
M	4.134 x 2.560 x 0.748
L	4.606 x 2.874 x 0.945
XL	5.906 x 3.622 x 1.102

PROTECTION CLASS IP 54

With intermediate ring in TPE, without battery compartment (Sizes S, M, L – ABS and PMMA versions).

YOUR ADVANTAGES

Optionally in material permeable to infra-red signals from stock.

Available with or without battery operation. Snap-in battery compartment lid; if required, this can be secured by a screw.

Recessed operating area for the protection of the membrane keypad.

Large interface panel on the long side.

APPLICATIONS

Remote control units of many different kinds.

Measurement and control engineering. Control technology.

Medical and laboratory technology.

Peripheral and interface equipment.

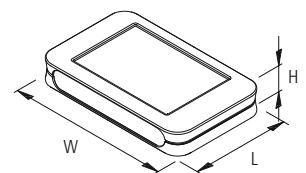

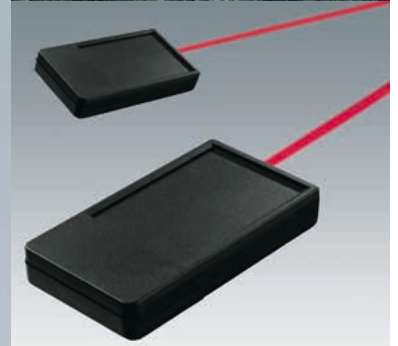

COMPACT TECHNOLOGY

THE PRODUCT

The pocket-sized DATEC-POCKET-BOX range offers a remarkable amount of technology in a minimum of space, as well as sturdy construction.

The sealings fitted in the upper and lower parts ensure greater protection against dust and water entry.

This means that the case can easily be used in rough conditions.

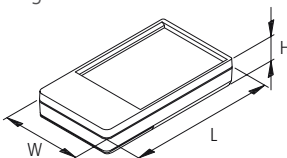

For ordering information, drawings and 3D models visit www.okwenclosures.com

YOUR ADVANTAGES

Plain surfaces for individual machining and interfaces.

Optionally in infra-red permeable material from stock. For utmost efficiency the case is equipped with a recessed, polished front face (M/L).

Recessed operating area for the protection of the membrane keypads.

Fastening pillars for PCBs and components.

MATERIAL / COLOR

- ABS (UL 94 HB), off-white (RAL 9002)
 - ABS (UL 94 HB), black (RAL 9005)
 - PMMA*, black (RAL 9005)
- *PMMA (plexiglass®)

OUTSIDE DIM. IN INCHES

Sizes	L x W x H
S	3.346 x 1.811 x 0.630
M	4.134 x 2.283 x 0.728
L	4.724 x 2.560 x 0.866

PROTECTION CLASS IP 54

With sealing, already optionally prefitted in the top.

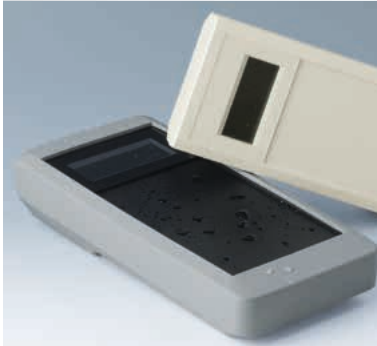

MOBILE DATA COLLECTOR

MATERIAL / COLOR

- ABS (UL 94 HB), off-white (RAL 9002)
- ABS (UL 94 HB), black (RAL 9005)

OUTSIDE DIM. IN INCHES

Sizes	L x W x H
S	5.984 x 3.268 x 1.319
M	7.677 x 3.976 x 1.732
	7.677 x 3.976 x 2.323
L	9.921 x 4.764 x 1.969

PROTECTION CLASS IP 65

With sealing kit (accessory) and in versions II-IV only in conjunction with the adhesive foil for the display window.

THE PRODUCT

A series of cases tailored exactly to the field of mobile data collection has been developed under the name DATEC-MOBIL-BOX.

The cases combine robust functionality with a design that received an award from the iF (International Forum Design) in Hanover.

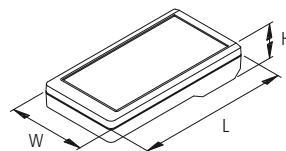

YOUR ADVANTAGES

Installation of standardized LCDs possible (contact addresses www.okwenclosures.com).

Display windows protect the fitted display modules and guarantee a high protection class IP 65 in the display area.

Plain surfaces for interfaces.

Recessed operating area in order to protect the membrane keypads.

With/without battery compartment.



COMPACT SOLUTION

THE PRODUCT

The new DATEC-COMPACT series of mobile enclosures has a compact and robust design.

The enclosures are ergonomic to hold and thus ensure fatigue-free operation.

Besides enclosures without sealing with protection class IP 41, there are also enclosures with foamed sealing with protection class IP 65 for outdoor use.

YOUR ADVANTAGES

3 sizes, with plenty of room for the electronics and all of your operating elements.

Enclosure with / without battery compartment, accessible from outside: three rechargeable batteries guarantee a reliable 3V power supply (size S: 3 x AAA, sizes M & L: 3 x AA).

Plain surfaces for interfaces.

Recessed operating area in order to protect the membrane keypads.

MATERIAL / COLOR

Plastic parts:

- ASA+PC-FR (UL 94 V-0), off-white (RAL 9002)
- ASA+PC-FR (UL 94 V-0), lava

UV-stabilised material, also suitable for outdoor use.



Versions with 2 integrated contact pins available from stock



SYSTEM VARIETY

OUTSIDE DIM. IN INCHES

DATEC-COMPACT	L x W x H
S	5.354 x 2.913 x 1.260
M	6.772 x 3.622 x 1.535
L	8.110 x 4.331 x 1.850

PROTECTION CLASS IP 41

Without sealing.

PROTECTION CLASS IP 65

With foamed polyurethane sealing.

YOUR ADVANTAGES

If needed, all-in solution for charging with integrated contacts.

Wall holder open from below to allow additional contacts.

SD cards/USB connectors can be inserted within the sealed compartment.

Corrosion-free stainless steel screws with reliable Torx heads.

There is a choice of two colours from stock, special colours are available on request.

APPLICATIONS

Mobile data recording.

Measuring and control technology.

Control technology.

Medical and laboratory technology.

Environmental technology.

Outdoor.

...and much more.

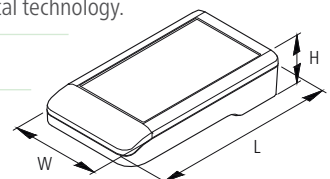



XS



S

M

L

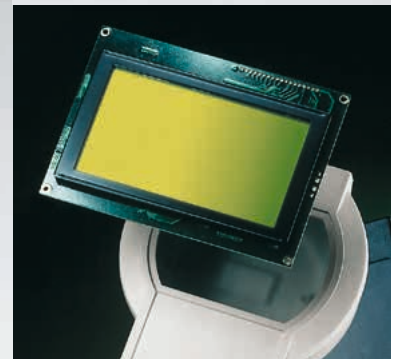

THE DISPLAY PROFESSIONALS

THE PRODUCT

The round form of the head of the DATEC-CONTROL range of enclosures allows the installation of larger displays with graphics capability.

Particular attention was also paid to the ergonomics of the new design.

The cases are thus very comfortable to hold and easy to operate.

VISUALIZATION

Installation of standardized LCDs and graphics-capable displays possible (contact addresses www.okwenclosures.com). With this equipment, curves, diagrams, symbols and texts can easily be illustrated and the functions explained to the user so that they are easy to understand.

Display windows protect the fitted display modules and guarantee a high protection class in the display area in conjunction with the sealing kit for the enclosure. Easy assembly with included adhesive foil.

MATERIAL / COLOR

- ABS (UL 94 HB), off-white (RAL 9002)
- ABS (UL 94 HB), black (RAL 9005)

DATEC-CONTROL MOBILE



FLEXIBLE POWER SUPPLY

OUTSIDE DIM. IN INCHES

DATEC-CONTROL	L x W x H
XS	7.874 x 2.283/3.701 x 1.555
S	8.976 x 2.835/4.606 x 1.850
M	9.567 x 3.543/5.118 x 2.362
L	10.472 x 3.543/5.670 x 2.362

OPTIONAL BATTERY COMPARTMENT

XS	2 x 1.5 V mignon cells (AA)
	3 x 1.5 V mignon cells (AA)
	1 x 9 V flat battery (PP3)
S	4 x 1.5 V mignon cells (AA)
	1 x 9 V flat battery (PP3)
M/L	4 x 1.5 V mignon cells (AA)
	5 x 1.5 V mignon cells (AA)

DATEC-CONTROL XS, S

Available without or with battery compartment. Easy battery replacement.

Lid of battery compartment optionally with latch and/or fixed by screws.

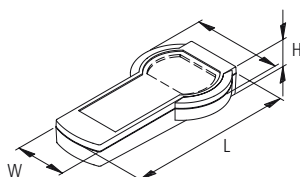

DATEC-CONTROL M, L

Available without/with battery compartment. For mounting the battery compartment there are two positions possible according to the requirements of your components configuration. Easy battery replacement. Station for charging electronics etc. available as accessories, see page 34.

In case of high power requirements, up to 5 AA batteries can be used.

Push-on end cover can also be permanently fixed if needed.

DATEC-CONTROL MOBILE/BASE



XS/S



XS/S



M/L



M/L



PERFECT CONTACTING

BASE

Ergonomically inclined position allows convenient reading of data and operating. Displays and readouts are easily legible.

Stations XS and S for desk case applications.

Stations M/L for table top and wall mounting applications.

CHARGING/TRANSMITTING

Easy transmission of data and charging current. Contacts as accessories or already supplied with the enclosure sets XS/S.

Stations offer sufficient volume for electronic components.

CHARGERS FOR RECHARGEABLE BATTERIES

In the M/L station there is even room for a battery compartment. The station can thus be used as an external battery charger provided it is suitably configured.

Any number of battery packs are thus no longer a problem.

Replaceable batteries guarantee long operating times for the device. This is an advantage when using it in the field.



XS



XS



M/L

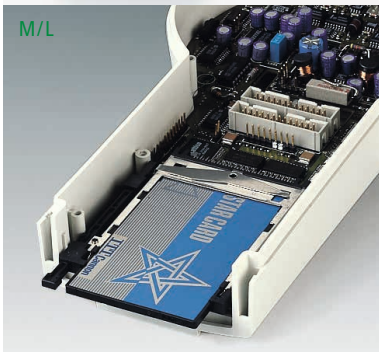

CONVINCING ALL DOWN THE LINE

PROTECTION CLASSES ENCLOSURES

With sealing kit (acc.) and, in version II, in conjunction with the adhesive foil for the display window, protection class IP 65 is possible with XS and S, as well as IP 54 with M and L.

In the XS/S enclosure set, an additional seal for the contacts is required.

PROTECTED

The protectors take up the elegant design features of the basic enclosure and give the enclosures excellent impact protection. They also serve as surface protection for peripheral equipment, devices etc. Sizes M/L also have an individually adjustable shoulder strap.

Space for PCMCIA card (M/L), protected mounting – easy access.

APPLICATIONS

Mobile data collection and transfer via modem, ISDN or infra-red technology.

Measuring and control technology.
Digital control technology.

Machine building and construction units.

HAND-TERMINAL



ROBUST "GRIP"

THE PRODUCT

The HAND-TERMINAL is designed for electronic devices that require a robust hand-held enclosure.

Technical refinements in the design of the unit guarantee pleasant day-to-day work but also allow a firm grip whenever necessary.

A front panel version is available for the installation of complete pre-assembled electronics units.

YOUR ADVANTAGES

Robust enclosure made of impact-resistant, flame-resistant material.

Large, recessed area on the front side for the installation and protection of interfaces, screwed cable glands, plug-in connections etc.

Suitable for emergency stop switches and enable pushbuttons.

Available with or without battery operation.

Optimum weight distribution.

MATERIAL / COLOR

Enclosure:

- PC+ABS (UL 94 V-0), off-white (RAL 9002)
- PC+ABS (UL 94 V-0), black (RAL 9005)

Front panel:

- Aluminum, matt anodized

OUTSIDE DIM. IN INCHES

8.661 x 4.724 x 2.560

PROTECTION CLASS IP 65

In conjunction with the sealing kits available as accessories (enclosure, front panel)



THE WAY AHEAD

MATERIAL / COLOR

Enclosure:

● ABS (UL 94 HB), off-white (RAL 9002)

● ABS (UL 94 HB), lava

Elastic cap:

● TPE, orange

OUTSIDE DIM. IN INCHES

7.087 x 3.386 x 1.772

PROTECTION CLASS IP 41

THE PRODUCT

SENSO-CASE is ideal for ergonomically favourable single-handed operation, and offers many different possible applications.

Specific measuring, controlling and signalling tasks as well as the recording of data using opto-electronic components can be carried out easily, quickly and reliably.

Suitable for right handed and left handed operation.

YOUR ADVANTAGE

Ideal for pre-assembled electronics packages, including those with integrated interfaces.

Also available with push-button for immediate and/or temporary operation.

Internal power supply with 2 x 1.5 V mignon cells (AA) or 1 x 9 V flat battery (PP3). Battery compartment for 2 x AA as well as cable glands and a set of strain relief for cable operation available as accessories. Simultaneous operation using standard/rechargeable batteries and cable possible.



COMFORTABLE TO CARRY

THE PRODUCT

Functional handle for many different tasks and situations.

In this way, CARRYTEC improves the manageability of large-volume equipment and supports users in their everyday work.

Depending on the application – indoor or outdoor – this innovative enclosure is available in different materials, e.g. high-impact, reinforced plastic material for tough conditions, colors etc.

MOBILE

The handle conveys a completely new carrying sensation. Located above the center of gravity of the enclosure, it guarantees a balanced product design and ergonomic handling. A soft insert ensures a perfect, non-slip grip. CARRYTEC is also characterized by an especially large surface area that is ideal for user interfaces.

Lateral recesses in the bottom part also give the user a secure grip when running wireless or wired applications.

MATERIAL / COLOR

Enclosure/Handle pad:

- ABS (UL 94 HB), off-white (RAL 9002)
- Handle pad TPE, volcano
- ASA+PC-FR (UL 94 V-0), lava
- Handle pad TPE, orange

Protection bag, shoulder strap (S, M):

- gray

High-quality stainless steel Torx screws for the enclosure, the station and the holding clamp.



SECURELY HELD

OUTSIDE DIM. IN INCHES

CARRYTEC	W x H x D
S	8.74 x 8.07 x 3.15
M	10.63 x 9.72 x 1.65* NEW
	10.63 x 9.72 x 3.58
L	13.70 x 11.93 x 4.61

* Size M: now also available with flat bottom part for the installation of tablets or the like that have reduced space requirements

PROTECTION CLASS IP 54

Enclosure with sealing (accessories).

WALL APPLICATIONS

A station is available as an accessory to allow the unit to be placed securely on a wall.

Available with or without base plate.

The enclosure snaps securely into the station. It can be removed easily by pulling the handle.

CHARGING / TRANSMITTING

Optional integration of charging and data transfer contacts.

The station offers adequate space for the electronics.

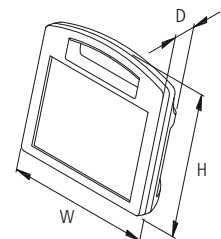

CARRYTEC DESK-TOP/BASE



EASY TO OPERATE

DESK-TOP

The station can also be used to be placed on a table.

The rubber feet included in the supply of the base plate ensure that the table-top version does not slip.

The enclosure snaps securely into the station.

ERGONOMIC

The operating area is inclined by 15° (with or without station). This facilitates ergonomic tilted positions.

A real asset when operating and reading – also in different distances or with different perspective.

Ample installation depth and plenty of room for interfaces, yet slim appearance

Flat, impact-protected areas on the bottom part of the enclosure for installing interfaces, plug-in connectors, cable inlets and outlets, peripheral equipment etc.

Very large operating panel for pushbuttons, membrane keypad, display, touch screen etc.

Easy transmission of data and charging current. Station with flange as accessory.

Sizes S and M: Optional protection bags for accessories, sensors etc. available. Cable connectors and interfaces can be pre-assembled, ready to use.



WITH SYSTEM CONNECTION

ALL-ROUNDER

Thanks to its easy-to-hold shape adapted to human gripping habits, CARRYTEC offers a unique variety of possible uses, indoors and outdoors: mobile – desk-top – wall-mounted – rail-mounted – round tube – tripod – support arm

The enclosures are particularly robust and easy to clean. Versions in reinforced plastic material can stand up to tough conditions in everyday use.

HOLDING DEVICES

Optional holding clamp available for mounting on round tubes and standard rails DIN EN ISO 19054.

The flat area on the back of the enclosure also allows it to be mounted on tripod or support arm systems, and the handle, since it is pointing downwards, allows fast positioning and alignment of the viewing and operating panels. Effortless swivelling, tilting, inclining, turning, pulling etc. – all this is no problem.

APPLICATIONS

Medical and laboratory technology. Wellness.

Peripheral and interface equipment.
Communications technology.
Safety engineering.

Data recording. Monitoring.

Plant and machine construction.

Measuring and control technology.

Agriculture and forest management.



NOTICEABLY PLEASANT TO CARRY

THE PRODUCT

A convex design to match the curves of the body is the characteristic feature of the ERGO-CASE range of cases.

As "bodycases" they for the first time make it possible for the user to wear the unit comfortably – whether on their arm, chest or waist.

The innovative design not only makes it easier to operate but also easier to read off.

YOUR ADVANTAGES

Ready for use with a large range of accessories, e.g. wrist strap, belt strap, strap eyelet, belt/pocket clip etc.

Available for operation either with or without batteries. Add-on battery compartments (M, L) with snap-in battery compartment lid; if required, this can be secured by a screw. Size S with integrated supports. Optimum weight distribution.

Flat surface for individual interfaces on the front side.

MATERIAL / COLOR

ERGO-CASE XS:

- ABS (UL 94 HB), off-white (RAL 9002)
- ABS (UL 94 HB), black (RAL 9005)

Intermediate ring XS:

- TPE, volcano

ERGO-CASE S, M, L:

- ABS (UL 94 HB), off-white (RAL 9002)
- ABS (UL 94 HB), black (RAL 9005)

Display trim L:

- ABS (UL 94 HB), off-white (RAL 9002)
- ABS (UL 94 HB), black (RAL 9005)
- PC, translucent

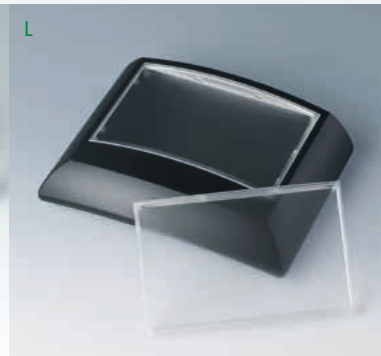

INTERFACE PROFESSIONAL

OUTSIDE DIM. IN INCHES

ERGO-CASE	L x W x H
XS	3.228 x 2.205 x 0.945
S	3.150 x 3.780 x 1.260
	3.150 x 3.780 x 1.732
M	5.906 x 3.937 x 1.575
	5.906 x 3.937 x 2.165
L	5.906 x 7.874 x 2.126
	5.906 x 7.874 x 2.717

PROTECTION CLASS IP 54

Sizes S, M and L with sealing/sealing kit (accessory), except size L with display panel.

YOUR ADVANTAGES

Available either with flat or with high top part for individual installation configuration.

Recessed operating area in order to protect the membrane keypad.

Wall mounting with removal prevention. Easy transmission of data and charging current. Contacts as accessories.

APPLICATIONS

Mobile data recording and transmission in the fields of medical, laboratory and measuring technology.

Storage and sales logistics.

Digital open and closed-loop control technology.





OPTIMUM CONNECTIONS

THE PRODUCT

The new CONNECT is ideal for wired applications. It consists of a convex enclosure shell and a flattened shell with operating area, with identical cutouts for end top at either end.

The two case shells are snap together with a robust and reliable clip, which leads to time savings during assembly.

Cable glands and/or end parts are optionally available to complete the enclosure shells.

YOUR ADVANTAGES

The enclosures are available with identical and ergonomic profiles in three different lengths (2.992", 4.567", 6.142") in the color off-white (RAL 9002).

Through the absence of screws, the top side of the enclosure can be freely selected.

Two enclosure shell designs, convex and flat.

The two shells snap into each other, no screw connection.

Recessed operating area for protecting the membrane keypad or product label.

MATERIAL / COLOR

Enclosure shells and end parts:

- ASA+PC-FR (UL 94 V-0), off-white (RAL 9002)

Cable glands:

- TPE, volcano

PROTECTION CLASS IP 40



MANY DIFFERENT APPLICATION OPTIONS

OUTSIDE DIM. IN INCHES

CONNECT	W x L x H
76	2.126 x 2.992 x 0.866
116	2.126 x 4.567 x 0.866
156	2.126 x 6.142 x 0.866

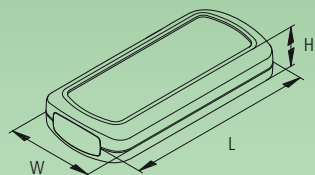

YOUR ADVANTAGES

- End panels and/or cable glands can be fitted.
- Integrated strain relief with the cable gland kit.
- There is enough room for the installation of compact displays, LEDs and USB connectors.
- The flattened enclosure shell has four attachment domes for mounting PCBs and built-in components.
- Holding clamp for round tubes up to \varnothing 32 mm available as accessory (for case lengths 116 and 156).

APPLICATIONS

- Data systems engineering.
- Network technology.
- Building services systems.
- Safety engineering.
- Medical and therapeutic applications.
- Measurement and control technology, and much more.

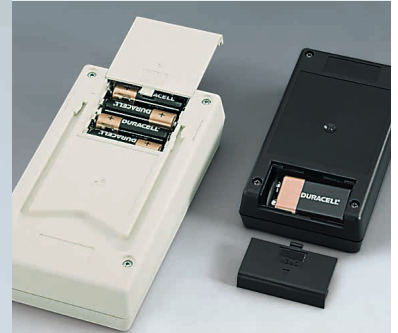

DIGITAL OR ANALOG

THE PRODUCT

The name HAND-HELD-BOX stands for tried and tested, low-priced cases for measuring instruments of handy pocket size, e.g. continuity checker and volt meter, field intensity meter, digital thermometers etc.

The cases are particularly ergonomic and are also operator-friendly.

The applied individuality meets special requirements, depending on the suitability and application.

YOUR ADVANTAGES

Prepared for mounting of digital or analog display modules.

Display windows protect the integrated displays. Simple assembly with adhesive foil.

Snap-in battery compartment lid for quick battery exchange.

With or without switch cap (P).

Raised front area on the bottom part to accommodate plugs.

MATERIAL / COLOR

- ABS (UL 94 HB), off-white (RAL 9002)
- ABS (UL 94 HB), black (RAL 9005)

OUTSIDE DIM. IN INCHES

Type	L x W x H
P	5.709 x 3.150 x 1.437
M	5.709 x 3.150 x 1.516
N	7.087 x 3.937 x 1.732

PROTECTION CLASS < IP 40

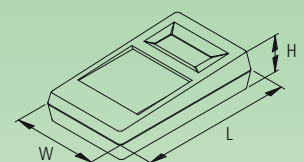



EXCITING AND VERSATILE

MATERIAL / COLOR

Plastic parts:

- ABS (UL 94 HB), off-white (RAL 9002)

Al front panel:

- Aluminum, anodized

Installation assembly kit:

- ABS (UL 94 HB), off-white (RAL 9002)

Choice of individual color / decor.

OUTSIDE DIM. IN INCHES

Size	L x W x H
S	5.315 x 7.480 x 0.965
	5.315 x 7.480 x 1.358
M	6.496 x 8.858 x 1.004
	6.496 x 8.858 x 1.398
L	7.677 x 10.827 x 1.043
	7.677 x 10.827 x 1.437

THE PRODUCT

The growing demand in the field of data visualization calls for innovative products tailor-made to meet the requirements of today's users.

The new INTERFACE-TERMINAL meets all of the requirements of a modern man-machine interface. Here the user himself decides whether he would like to use the device as a mobile or as a stationary unit.

APPLICATIONS

Unique variety of applications:
Mobile – desk-top – wall mounted

Peripheral and interface equipment. Office applications. Communications technology.

Safety engineering. Biometrics.

Medical and laboratory technology. Wellness.

Automation. Measuring/regulating/controlling.

INTERFACE-TERMINAL MOBILE/BASE



CONTACT-FRIENDLY

MOBILE

Maximum mobility and independence.

With/without battery compartment (5 x AA), accessible from the outside, incl. protection against incorrect insertion as well as anti-rotation device.

User-friendly design with attractive flat styling in the handle area. Finger recesses on the underside ensure a secure grip.

Available with either flat or high bottom part for individual installation configurations, interfaces, cable inputs and outputs etc.

CHARGING / TRANSMITTING

Easy transmission of data and charging current. Contacts as accessories.

Case available either to hang in position (desktop application) or base with snap-in mechanism for secure desktop and wall mounted applications.

A flat wall suspension element as a base or for contacts is available.

The base offers adequate space for the electronics.

PROTECTION CLASS IP 54

With sealings (accessories).

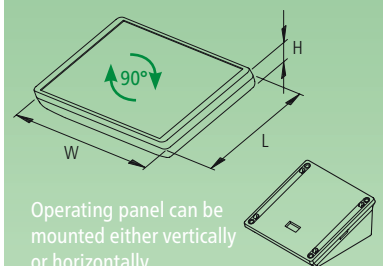

Operating panel can be mounted either vertically or horizontally.



EASY TO OPERATE

MAX. DISPLAY SIZES

S	6.4"	16 cm
M	8.4"	21 cm
L	10.4"	26 cm

The INTERFACE-TERMINAL provides sufficient space for large-area touch screen displays. Thus allowing simple, intuitive and interactive operation of the controls on the touch screen. The advantage is a perfect navigation experience.

ERGONOMIC

Operating panel inclined by 20°. Ergonomically ideal for operating and reading – whether vertically or horizontally mounted.

Rubber feet are included in the kit to ensure non-slip desktop positioning.

BASE-MOUNTED VARIANTS

Individual desktop cases can be assembled from different components to match the component configuration.

Case can also be screwed to the base (desk). Assembly screws hidden on the underside.

Alternatively, the case snaps onto the base (desk/wall). If required, the unit can be secured by a latch lock.

INTERFACE-TERMINAL WALL



INTERFACE PROFESSIONAL

EFFICIENT

Unique "interface" between a stationary and a mobile component.

Assembly can be significantly simplified by predefined, snap-in interfaces.

You can also benefit from the ease of assembly when equipping and connecting up the interfaces; plug-in connectors also prevent wiring errors whenever servicing is required.

WALL MOUNTING

(1) Direct wall mounting. The ergonomically inclined base offers plenty of space for connectors, electronics as well as wiring.

(2) Separate wall suspension element for low-profile wall mounting, suitable for cases without base. The wall suspension element is prepared for contacts (accessories) for transmitting data and current.

RATIONAL WALL MOUNTING

The case can be mounted on the wall as a closed unit – vertical or horizontal orientation, depending on requirements.

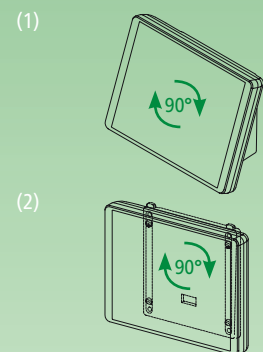



ELEGANT DESIGN FRAMES

PRECISE INSTALLATION

Vertical or horizontal orientation, depending on requirements.

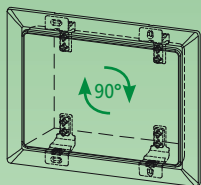

DESIGNS

If the architectural standards are particularly high, or in historically valuable buildings, INTERFACE-TERMINAL enclosures can also be harmoniously integrated in walls or front panels. Installation in plant and machinery is also possible.

Our speciality: individual colors and a wide choice of finishes. Please select the relevant Part-No. and tell us your color or the standard finish you requirements.

INSTALLATION

Easy installation: Mount holders on the fully assembled enclosure. Place the enclosure with holders in the wall/front panel and align it. Mark and drill mounting holes. Then bolt the enclosure with the holders from the front and push on the design frame.

Depending on requirements, there are different installation options: enclosures with top part, glass panel or ABS front panel. In the raised top part, special functions can be integrated laterally, for example openings for acoustics.



ELEGANT CENTRAL CONTROL UNIT

THE PRODUCT

The new NET-BOX wall-mounted enclosure series has a fresh and exciting curved appearance.

The flat design of the enclosure gives you plenty of scope for installing your electronics, smaller displays and large-volume connectors. The design on the underside is also exciting: the wall mounting is on the right and left, and in between there is a surface for interfaces. When the wiring for the electronics has been completed, the connectors are elegantly covered by the top lid - all this without any visible screws. With these design features and

the elegant colors of light gray/lava, the NET-BOX fits ideally into modern surroundings.

Thanks to the UV-stabilised V0 material used and the optional IP 65 protection class, this new series of enclosures can also be used for terminal units outdoors.

With the optional infill cover cover you also have the option of fitting a further PCB and visually closing the bottom part of the enclosure.

MATERIAL / COLOR

Top part, trim:

- ASA+PC-FR (UL 94 V-0), light gray (RAL 7035)

Bottom part, cover:

- ASA+PC-FR (UL 94 V-0), lava

High-quality stainless steel screws with Torx heads.



EXCITING SOLUTION

OUTSIDE DIM. IN INCHES

NET-BOX	W x H x D
140	5.512 x 5.512 x 1.831
180	7.087 x 7.087 x 1.909
220	8.661 x 8.661 x 1.988

PROTECTION CLASS IP 65

With seal (accessory).

YOUR ADVANTAGES

3 sizes – plenty of room for electronics and interfaces.

Uniform appearance thanks to concealed screws and plug connections.

Compact electronics compartment with two PCB levels.

Easy, flush, three-point wall mounting.

APPLICATIONS

Data acquisition systems.

Data systems engineering.

Measuring and control technology.

Central control units.

Supervision terminals and access control.

Medical technology.

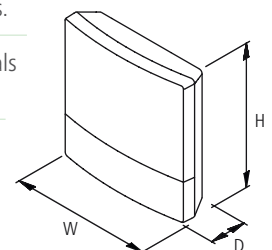



GUIDING DIALOG

THE PRODUCT

You can hardly present your communication and network equipment in a more attractive way.

DIATEC is an attractive eye-catching design for living and working environments. But this innovative range of cases also offers many functional benefits.

All design features are perfectly integrated. Depending on your requirements, different equipment options and connections are possible.

YOUR ADVANTAGES

Modern, flat enclosure design, ideal for table top and wall mounting applications.

Plain, recessed area on the bottom part for installation and protection of interfaces, screwed cable glands, plug-in connections etc.

Easy, invisible wall mounting.

Recessed operating area on the top for the protection of the membrane keypads and operating elements.

MATERIAL / COLOR

Enclosure:

- ABS (UL 94 HB), off-white (RAL 9002)
- ABS (UL 94 HB), lava

OUTSIDE DIM. IN INCHES

DIATEC	W x L x H
XS	5.906 x 6.102 x 1.457
S	8.268 x 7.874 x 1.890
M	10.630 x 7.874 x 1.890
L	12.992 x 7.874 x 2.283

PROTECTION CLASS IP 40



S/M/L

S/M/L

S/M/L

PRESTIGIOUS

DESIGN

DIATEC XS

Two-piece case, consisting of top and bottom part, screwed together. Integrated battery holder for 2 x 1.5 V AA batteries. Pre-shaped flush-mounting box contoured in the bottom part.

DIATEC S, M, L

Four-piece case, consisting of top and bottom part as well as two covers for concealing the assembly screws. If required, the snap-on covers can be locked to prevent unauthorized access. Integrated battery compartment for 2 x 1.5 V AA batteries or 1 x 9 V flat battery.

DIATEC S, M, L

Separate slot-in panels can be used as interior partitions, for example to guard the electronics when changing batteries. This allows the complete pre-assembly of the electronics unit. The technician on site only has to mount the unit on the wall and connect up the relevant cables. Connection can be effected from the left and/or from the right-hand side. The actual case does not have to be opened to do this, only the snap-on side trims.

Accessory hinged lids, in case color or transparent plastic, protect the dialog zone.

APPLICATIONS

Systems for data collection on the job.

Access and security controls.

Peripheral equipment for computers, data system engineering.

Measuring and controlling.

Medical field and laboratory technology.

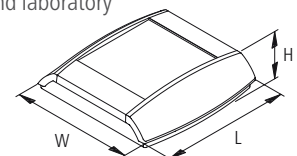

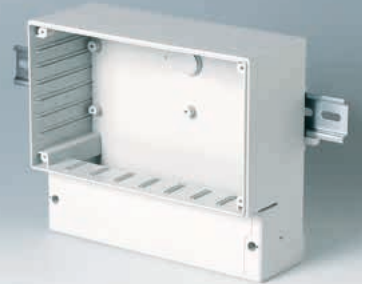
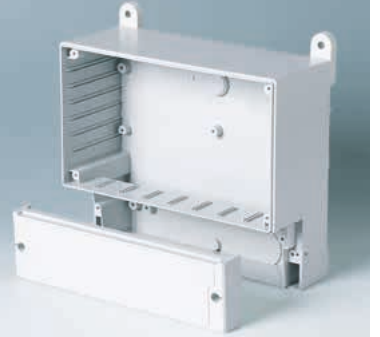

MEASURING, CONTROLLING, REGULATING

THE PRODUCT

The robust range of wall mounted cases with freely accessible terminal compartment for easy component mounting and wiring.

The models fitted with a transparent cover have an easy-to-operate closure system ensuring comfortable opening and closing.

These cases are particularly suitable for use in heating, air conditioning and ventilation technology, measurement and control technology, for machine and industrial controllers etc.

YOUR ADVANTAGES

Available either with or without transparent cover to protect the display and operating elements. Opening either on the right or on the left.

Alternatively available with front cover / front panel attachment (accessory).

Screw bosses and guides for the vertical and horizontal installation of printed circuit boards and mounting plates.

Direct wall mounting or external wall mounting brackets (accessory). Optional DIN rail mounting kit (accessory).

MATERIAL / COLOR

● ABS (UL 94 HB), light gray (RAL 7035)

Enclosure with transparent cover:

● PC (UL 94 5V), light gray (RAL 7035)

OUTSIDE DIM. IN INCHES

W x H x T without transp. cover	W x H x T with transp. cover
6.54x6.30x3.15/4.25	7.40x6.30x4.17/5.28
8.39 x 7.28 x 3.54	9.25 x 7.28 x 4.69
10.12 x 8.62 x 4.80	11.02 x 8.62 x 6.14
11.65 x 10.24 x 3.74	12.60 x 10.24 x 5.08
14.29 x 12.44 x 5.28	15.35 x 12.44 x 6.57

PROTECTION CLASS IP 65

With transparent enclosure cover or front lid.

For ordering information, drawings and 3D models visit www.okwenclosures.com



IP 65 IN A CLICK!

MATERIAL / COLOR

● ABS (UL 94 HB), light gray (RAL 7035)

OUTSIDE DIM. IN INCHES

L x W x H

2.362 x 2.362 x 1.575

2.362 x 3.937 x 1.575

3.937 x 3.937 x 3.150

PROTECTION CLASS IP 65

With sealing, already prefitted in the top.

THE PRODUCT

OKW took a completely new approach in the development of SNAPTEC.

Instead of a conventional screw connection, assembly is effected using innovative and rational snap-in technique.

A visual improvement as well. The four openings are only for unlocking the unit for service or adjustment work on the final product, and are almost invisible thanks to the covers.

YOUR ADVANTAGES

Minimum effort with screwless case assembly. Save money, either during production or later with maintenance.

Easy wall mounting. Invisible wall mounting in pre-molded shafts within the base part. As an alternative, there are separate wall mounting brackets for exterior mounting available as accessories.

High bottom parts guarantee maximum surface area for fitting screw-in cable glands and interfaces.

SMART-BOX



SMART SOLUTION

THE PRODUCT

Your electronics cut a fine figure from the very first moment with the SMART-BOX.

Rounded surfaces create a pleasantly smart appearance which enhances the visual impact of your electronics. The cases also offer plenty of technical advantages.

YOUR ADVANTAGES

Convincing design. Flush-fitting trims mask the screw attachments; instead of light gray alternatively available in other colors (without UL 94 V-0) on request, e.g. to color-code the function or to match the case with your corporate image.

High-quality material ASA+PC (UL 94 V-0) for use in tough conditions. Also flame-retardant and self-extinguishing.

MATERIAL / COLOR

- ASA+PC (UL 94 V-0), light gray (RAL 7035)

High-quality stainless steel screws with high resistance to corrosion – even against aggressive media – through A2 stainless steel alloy.



SYSTEM VARIETY

OUTSIDE DIM. IN INCHES

Length	Width	Height
4.724	3.543	1.969
6.299		
5.512	4.331	2.362
7.874		
6.299	5.118	2.362
8.661		
7.087	5.906	2.362
11.024		6.693

PROTECTION CLASS IP 66

With sealing, already prefitted in the top.

YOUR ADVANTAGES

The cover retention device already included in the supply facilitates all installation and service work.

Optional lock accessory protects the unit from unauthorized opening.

Recessed operating area for the protection of the membrane keypad. Additional surface for labels on the underside.

Case feet (accessory), simply snap-in ensure non-slip desktop positioning.

APPLICATIONS

Ideal for design-oriented electrical and electronic applications, e.g. in heating, air conditioning and ventilation engineering, in control and system engineering, in safety technology etc.

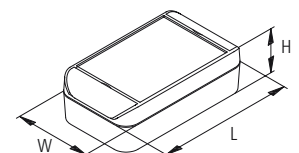

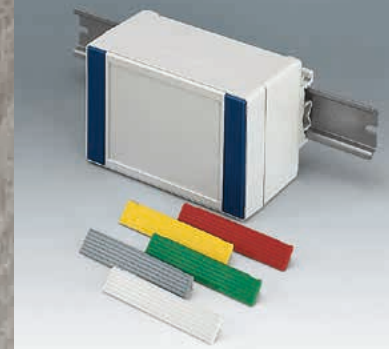

DUAL CASE SYSTEM

THE PRODUCT

Conceived as a dual case system, the ROBUST-BOX range offers a variety of installation options.

Both case shells are equipped with pre-molded threads. You as the user can now decide whether the flat or the high part of the case is to be used as the bottom part.

YOUR ADVANTAGES

Two standard materials (UL 94 HB):
ABS – approved as a terminal mounting case or in Polycarbonate – a solid and robust case, with high heat resistance for use in adverse environments.

Easy-assembly construction. The case shells can be used as either top or base section.

The cover fixings are outside of the sealed area.

MATERIAL / COLOR

One-colored:

■ ABS (UL 94 HB), light gray (RAL 7035)

■ PC (UL 94 HB), light gray (RAL 7035)

Colored cover strips:

■ PC (UL 94 HB), silver gray (RAL 7001)

■ PC (UL 94 HB), red (RAL 3020)

■ PC (UL 94 HB), yellow (RAL1023)

■ PC (UL 94 HB), green (RAL 6024)

■ PC (UL 94 HB), blue (RAL 5017)

Rust-proof and captured fixing screws.

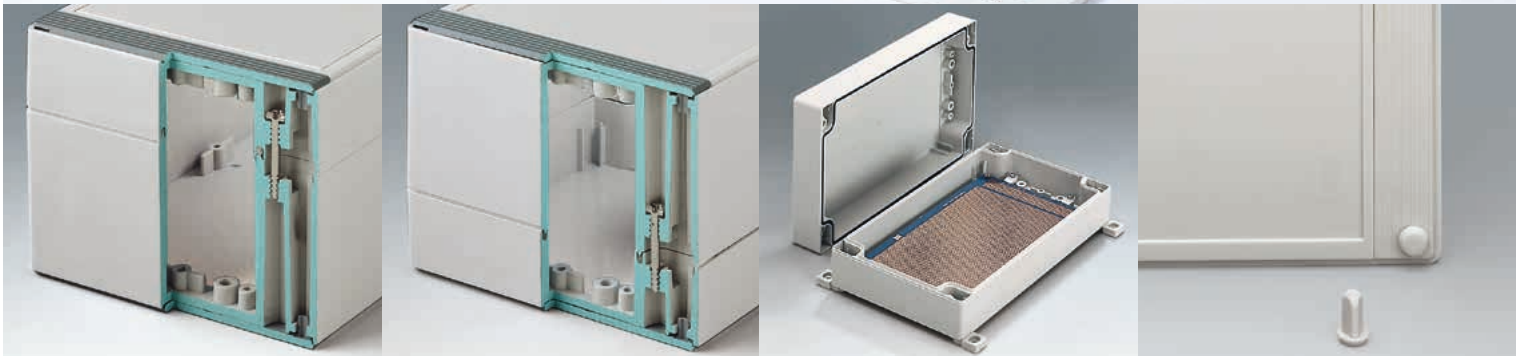

ROBUST VARIETY

OUTSIDE DIM. IN INCHES

Length	Width	Height
3.150	3.150	2.362/3.150
4.724		
6.299		
9.449		
4.724	4.724	2.362/3.543
7.874		
9.449		
6.299	6.299	2.362/3.543
9.449		2.362/3.543/4.724
11.811	7.874	3.150/4.724/6.299
9.449	9.449	3.150/4.724/6.299

PROTECTION CLASS IP 66

With sealing already pre-fitted.

YOUR ADVANTAGES

There is an area recessed by min. 0.031" for the mounting of membrane keypads.

Colorful cover strips for coding (as an alternative to the standard version in light gray).

Usable as a wall mount case or desktop case.

APPLICATIONS

This case system is especially suitable for a wide range of electric installations, e.g. heating, climate, ventilation, machine building and construction units.

But it can also be used in the electronics sector, e.g. as push-button case, for controllers, sensors, detection devices etc.

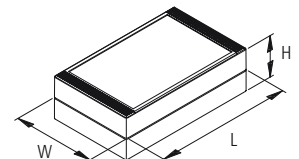



INDUSTRIAL QUALITY

THE PRODUCT

As an enclosure for terminal installations as well as for the electronics sector the IN-BOX program offers versatile options.

YOUR ADVANTAGES

9 base enclosures with high gloss surfaces and different heights.

Two standard materials:
ABS (UL 94 HB) or PC (V-2).

Top parts in case color or transparent.

Efficient quick-action lock made of stainless steel.

Recessed operating area to protect the membrane keypads.

MATERIAL / COLOR

One-colored:

■ ABS (UL 94 HB), light gray (RAL 7035)

■ PC (V-2), light gray (RAL 7035)

With transparent cover:

■ ABS (UL 94 HB), light gray (RAL 7035)

■ Top part PC (V-2), transparent

Quick-action lock made of stainless steel.

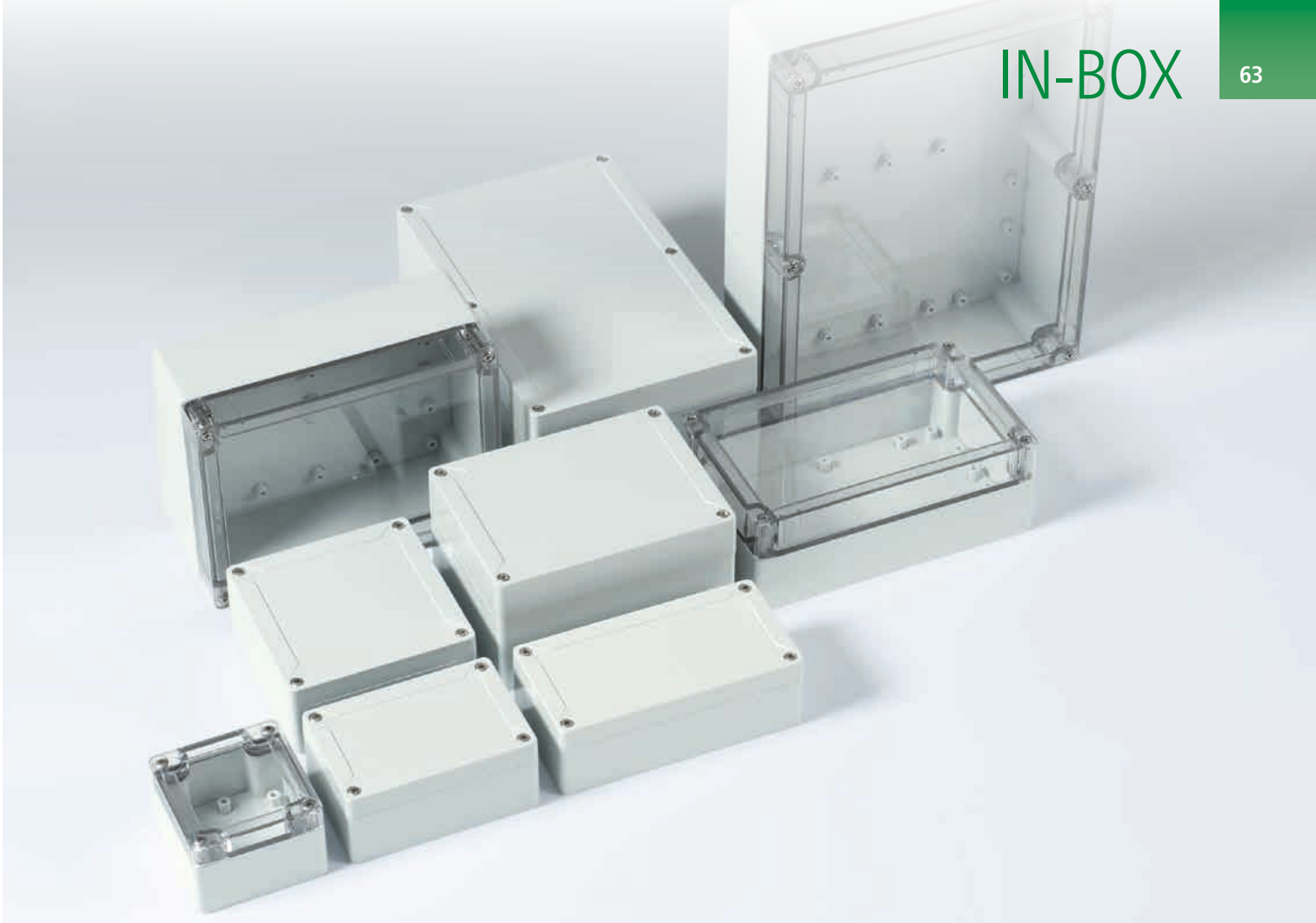

COMPREHENSIVE RANGE

OUTSIDE DIM. IN INCHES

Lenght	Width	Height
3.307	3.228	2.165/3.346
4.803	3.228	2.165/3.346
4.882	4.803	2.165/3.346
6.378	3.228	2.165/3.346
6.378	4.803	3.543
7.953	4.803	2.953/3.543
7.953	5.984	3.543
9.921	6.378	3.543/4.724
11.890	9.134	3.543/4.331

PROTECTION CLASS IP 66 / IP 67

With sealing already pre-fitted.

YOUR ADVANTAGES

Direct wall mounting or exterior wall mounting with wall mounting brackets (acc.). If required an internal hinge can be supplied as accessory.

Optional security kit for use with lead tags prevents unauthorized opening or removal.

Accessory DIN rails and mounting plates for individual installations and configurations.

APPLICATIONS

This case system is especially suitable for the wide range of electric installations, e.g. heating, climate, ventilation, machine building and construction units, security equipment etc.

But it can also be used in the electronics sector, e.g. as digital or analog instruments, sensor applications, interface enclosures, alarm systems etc.

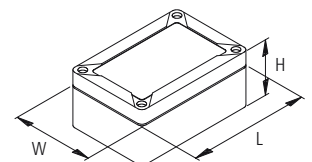

DATEC-TERMINAL



PROFESSIONAL OPERATIONAL DATA COLLECTION

THE PRODUCT

The DATEC-TERMINAL cases are uniquely designed to meet the requirements of stationary operational data collection.

A high degree of versatility is a characteristic of this range of cases.

Functional design and a wide range of accessories encourage universal use in the field of operational data collection, and also in other fields of application requiring wall mount and desktop enclosures.

YOUR ADVANTAGES

Mounting of standard pocket-size scanners.

With/without separate terminal section which is easily accessible.

Ergonomic shape. Operating area inclined by 20°. A real asset when operating and reading.

The cases are designed to save you time and money by being easy to assemble and service. The design is very attractive with all assembly screws being hidden from view.

MATERIAL / COLOR

Basic housing, covers, cover:

■ ABS (UL 94 HB), off-white (RAL 9002)

Transparent cover:

■ PC (UL 94 V-0), transparent

Profile plate:

■ Extruded aluminum profile

■ Cover strips ABS, pebble gray

Front panel:

■ Aluminum, matt anodized

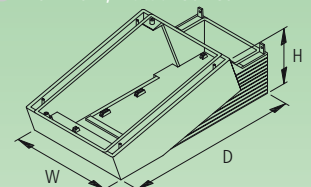

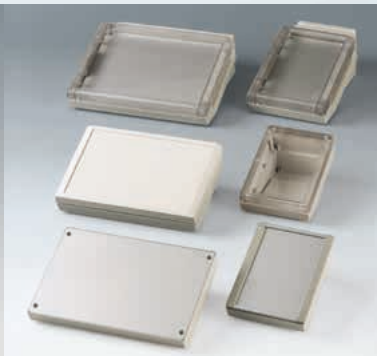

TABLE TOP OR WALL MOUNTED

OUTSIDE DIM. IN INCHES

Without separate terminal section

Basic housing	W x D x H
S	5.118 x 7.087 x 3.386
SL	10.394 x 7.087 x 3.386

With separate terminal section

Basic housing	W x D x H
M	6.614 x 10.709 x 3.976
L	11.890 x 10.709 x 3.976

PROTECTION CLASS IP 54

Only in combination with cover and closed lid.

YOUR ADVANTAGES

Invisible wall mounting with unauthorized removal prevention.

Screw pillars for PCB mounting are suitable for mounting eurocards 3.937" x 6.299" or double eurocard sizes (S, SL and L).

Flat area for machining and cutouts.

Recessed operating area for the protection of the membrane keypad.

APPLICATIONS

Systems for data collection on the job and machines.

Data system engineering.

Access and security controls.

Medical technology.

Measuring, controlling, regulating.

Heating and air conditioning technology.



PLEASANT TO USE

THE PRODUCT

Modern, attractive, flat styling characterises the COMTEC family of cases. This makes desk-top units easy to operate, and applications on the wall – then rotated by 180° – can be optimally mounted for the user.

The new "Softline" design gives the cases a high-quality appearance for housing equipment that needs to look good.

YOUR ADVANTAGES

Ergonomic design. A real asset when operating and reading.

Large area for interfaces at the top. Ideal for D-sub-plug connectors, round connectors etc. The interfaces may be permanently mounted on the board.

Flat or raised bottom part for large-volume components.

MATERIAL / COLOR

- ABS (UL 94 HB), off-white (RAL 9002)
- ABS (UL 94 HB), black (RAL 9005)

OUTSIDE DIM. IN INCHES

COMTEC	W	D	H
120 F	4.724	5.906	0.787/1.685
120 H			1.575/2.472
150 F	5.906	7.874	0.787/2.028
150 H			1.575/2.815
200 F	7.874	5.906	0.787/1.685
200 H			1.575/2.472
290 H	11.417	7.874	1.732/2.972

PROTECTION CLASS IP 40



TABLE TOP OR WALL MOUNTED

WALL MOUNTED APPLICATIONS

The ergonomically inclined front panel allows the case to be mounted within the operator's reach. Displays and readouts are easily legible for all users involved – be it the mechanical engineer, the operator etc.

Wall suspension element for rational wall mounting (accessory).

YOUR ADVANTAGES

Version I with closed bottom part. In version II the battery compartment can be fitted in the bottom parts (150 F/H, 200 F/H). Lid of battery compartment snapped-on.

Recessed operating area for the protection of the membrane keypad.

Self-adhesive case feet ensure reliable desk-top positioning.

APPLICATIONS

Systems for data collection on the job and machines.

Communications equipment. Access and security controls and data systems engineering.

Medical field and laboratory technologies.

Measuring and controlling.

Industrial regulation.

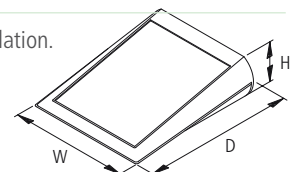

138



190



190 F/H



FUNCTIONALLY INCLINED

THE PRODUCT

The OKW DESK CASE range covers many different fields of application.

Choose a case that will fully meet your specific requirements in terms of size and tilt of the control panel.

Front panel versions are available for the installation of complete prefabricated electronics units.

YOUR ADVANTAGES

Various angles of inclination for the control panel, depending on requirements. Practical for operating and reading off the unit.

Suitable for numeric keypads and membrane keypads.

Prepared for the assembly of eurocards 3.937" x 6.299" (138/190/190F/190H).

Versions with ample space for large assemblies.

MATERIAL / COLOR

DESK CASE 138, 190 (one-colored):

● ABS (UL 94 HB), off-white (RAL 9002)

● ABS (UL 94 HB), black (RAL 9005)

DESK CASE 190 F/H, 220 & Combi desk case:

Bottom part

● ABS (UL 94 HB), pebble gray (RAL 7032)

Top part, attachment

● ABS (UL 94 HB), off-white (RAL 9002)

Front panel

● Aluminum, matt anodized

PROTECTION CLASS < IP 40



CONVENIENT

OUTSIDE DIM. IN INCHES

Types	W x D x H
DESK CASE ...	
138	5.433 x 7.480 x 1.260/2.126
190	7.480 x 5.433 x 1.260/1.850
190 F	7.480 x 5.433 x 1.240/1.850
190 H	7.480 x 5.433 x 2.146/2.756
220	8.661 x 6.142 x 2.047/3.937
COMBI DESK CASE...	
F	8.976 x 8.504 x 1.969/2.992
H	8.976 x 8.504 x 1.969/4.961

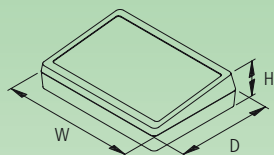

YOUR ADVANTAGES

Raised section giving space for easy installation of cable grommets and plug connectors (220, COMBI DESK CASE F/H).

Version with attachment for digital readouts, measuring equipment, encoders etc. (COMBI DESK CASE H).

APPLICATIONS

Systems for data collection on the job and machines.

Communications equipment. Access and security controls and data systems engineering.

Medical field and laboratory technologies.

Measuring and controlling.

Industrial regulation.

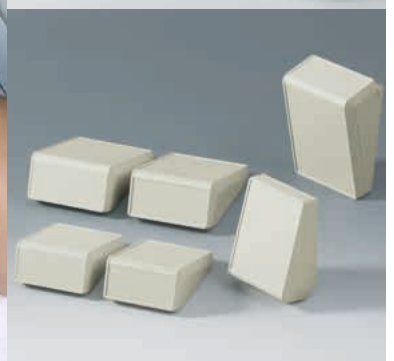

FACE TO FACE

THE PRODUCT

The new UNITEC range of cases is characterized by two operating panels with different inclinations at right angles to each other.

Depending on the application, these can be used for operating and/or reading-off purposes, thus allowing simultaneous applications, for example a doctor face to face with a patient.

YOUR ADVANTAGES

Modern appearance, ideally suited for desk-top or wall mounting.

Generously dimensioned dialog fields (72°/ 18° inclination). Ideal for large displays, touch screen surfaces, membrane keypads (0.055" depth), graphic overlays (0.024" depth), interfaces etc.

Pushbuttons, switches and display elements can be ergonomically operated and read off.

MATERIAL / COLOR

■ ABS (UL 94 HB), off-white (RAL 9002)

OUTSIDE DIM. IN INCHES

UNITEC	W x D x H
S	4.921 x 6.969 x 2.717/0.866
M	5.827 x 8.268 x 3.150/0.984

PROTECTION CLASS IP 40

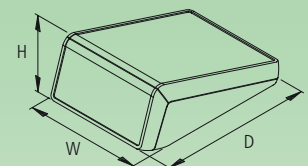



PERFECTLY SET FOR THE WALL

MORE INDIVIDUALITY

Individual electronics cases can be created through the use of an all-round digital graphic overlay specially tailored to illustrate your corporate identity (top and front parts recessed by 0.024").

On request we can print and mount digital graphic overlays for you in our own Service Center.

YOUR ADVANTAGES

Optional component mounting. Printed circuit boards can be positioned in the bottom, top and front parts. Since the operating panels are positioned at right angles to each other, it is also possible to install electronics and interfaces as complete ready-made packages.

Single or dual operating areas.

With/without battery operation 3 x AA / 5 x AA. Battery compartment lid snap-in and/or screw-on.

Hidden wall mounting.

APPLICATIONS

Data acquisition systems.

Building installations.

Data systems engineering. Communication.

Analysis, diagnostics and therapy applications.

Measuring and control technology.

Industrial regulation.

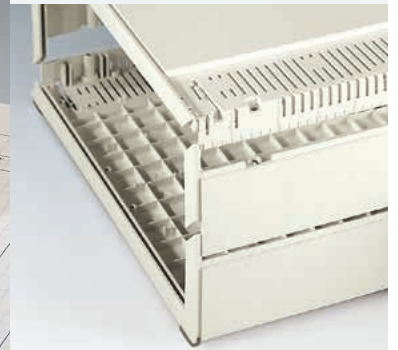

VERSATILE ELEGANCE

THE PRODUCT

The MEDITEC family of cases is characterized by convincing design features.

Mitred corners emphasise the modern enclosure design and technical refinement at the same time.

A clear form language allows universal application; distinctions can easily be implemented through layout or color design.

YOUR ADVANTAGES

High stability due to internal reinforcing ribs.

Enclosure design allows easy assembly.

Ergonomic sloping control panel with recessed area for protecting a membrane keypad or label. When using one side panel, the front cover ensures optimum closure of this gap.

Side trims are attached laterally, optionally available without / with ventilation.

MATERIAL / COLOR

● ABS (UL 94 HB), off-white (RAL 9002)

Trims:

● ABS (UL 94 HB), off-white (RAL 9002)

■ ABS (UL 94 HB), lagoon

Individual choice of colors on request.

ERGONOMICS

The ergonomically inclined sloping control panel facilitates viewing of the display instruments as well as operating.

The handle bar gives desktop applications an ergonomically favourable angle. It can also be used for carrying the device, see page 74.

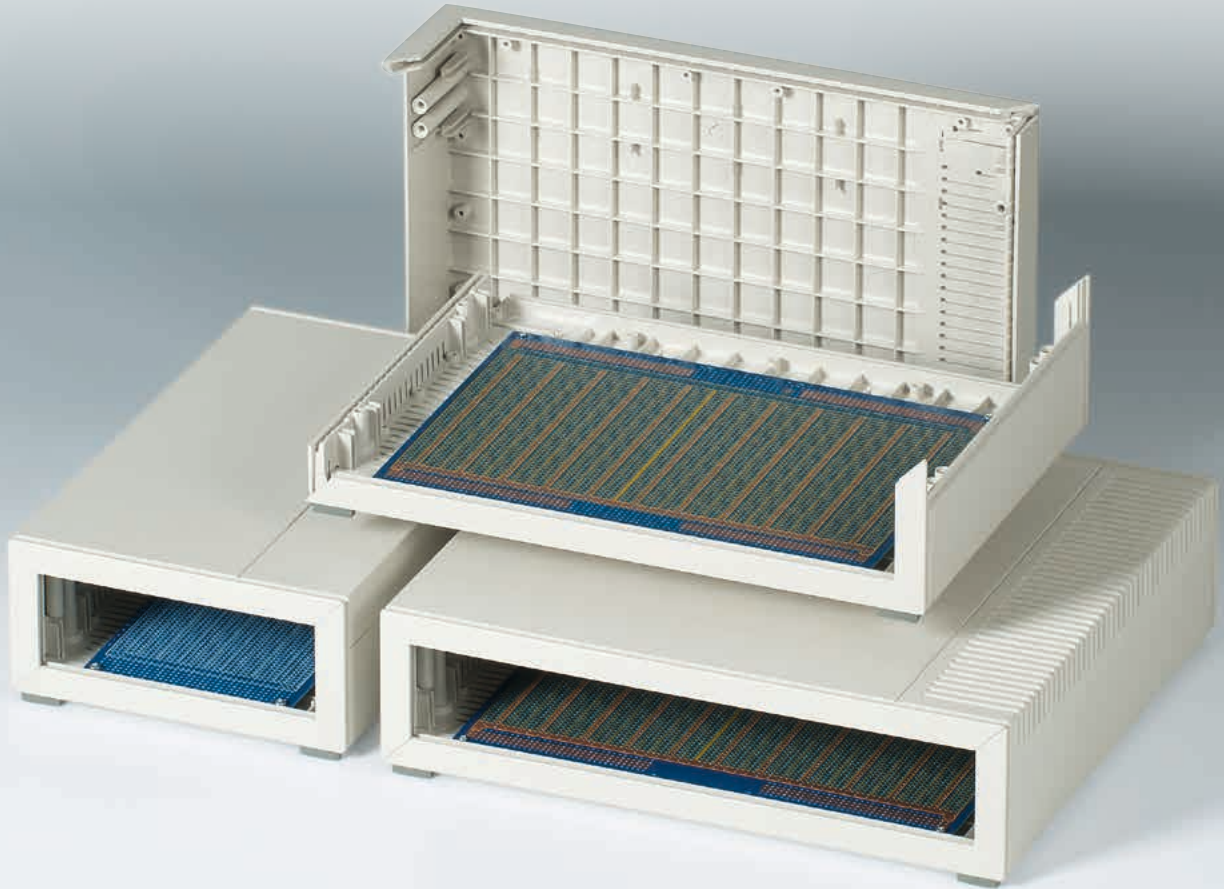

E 160

E 220

D 160

D 220

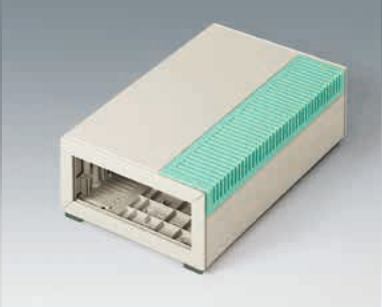

COMPATIBLE

OUTSIDE DIM. IN INCHES

MEDITEC	W x D x H
E 160	6.299 x 7.874 x 2.913
	6.299 x 7.874 x 4.882
E 220	6.299 x 10.236 x 2.913
	6.299 x 10.236 x 4.882
D 160	11.417 x 7.874 x 2.913
	11.417 x 7.874 x 4.882
D 220	11.417 x 10.236 x 2.913
	11.417 x 10.236 x 4.882

PROTECTION CLASS IP 40

YOUR ADVANTAGES

Eurocard sizes: single, double and extended.

Recessed vertical guide positions for fitting additional mounting plates behind the front panel.

Variable heights. The height can be increased by 1.969" when using the side panels (accessory). For additional heights two side panels can be assembled with one connector.

Plastic front and rear panels easy to machine.

APPLICATIONS

Medical field and laboratory technology.

Feedback control.

Measuring and control technology.

Control peripherals, modems and interfaces.

Communication and network technology.

Data collection.

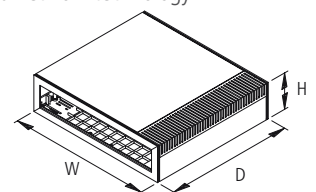



EASY TO OPERATE

WALL MOUNTING

A special asset is the application with ergonomically inclined sloping control panel. This allows the case to be mounted within the operator's reach. Displays and readouts are easily legible for all users involved – be it the mechanical engineer, or the operator etc.

But even without a sloping control panel, MEDITEC still looks good as a wall-mounted enclosure, e.g. for small networks.

RATIONAL WALL MOUNTING

Wall mounting brackets as accessory, easy to assemble.



ERGONOMIC HANDLING

CONVENIENT HANDLE BAR

Assembly can be effected from the inside as well as from the outside. The handle bar (accessory) can be removed in the 135° position.

MOBILE

For mobile applications the MEDITEC enclosures can be fitted with a handle bar. The handle bar ensures a perfect grip as well as an ergonomic handling located above the center of gravity of the enclosure.

If necessary, the adjustment mechanism allows the user to set a practical angle in situ, in increments of 30°.



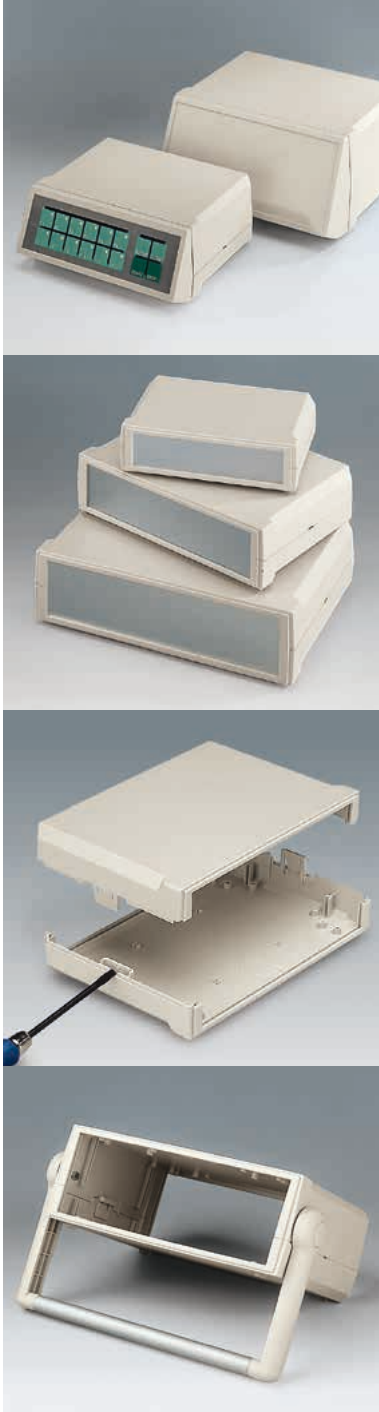

LARGE INTERFACE PANEL

MATERIAL / COLOR

- ABS (UL 94 HB), off-white (RAL 9002)
- ABS (UL 94 V-0), off-white (RAL 9002)

OUTSIDE DIM. IN INCHES

MOTEC	W x D	H
S	6.10 x 4.13	1.57/2.56/3.54
M	8.07 x 5.51	1.97/2.95/3.94
L	9.25 x 6.50	2.36/3.35/4.33

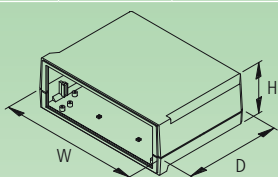

THE PRODUCT

Generously dimensioned, comfortable control and interface panels distinguish the MOTEC desktop device from conventional systems.

Different sizes and combinations offer a wide selection of attractive cases. Protection class IP 40.

Thanks to an innovative snap-in system, you can minimise your assembly work and at the same time improve the visual attractiveness of your products.

YOUR ADVANTAGES

Modern and fashionable design.

Different heights of cases for individual configurations.

Guide grooves for the vertical insertion of partitions and printed circuit boards.

Sloping control panel with recessed area to protect membrane keypads available as an accessory.

High-quality material ABS, optionally in UL 94 HB or UL 94 V-0 flame-resistant.



EVERYTHING SNAPS INTO PLACE

THE PRODUCT

The EURO CASE is extremely assembly-friendly.

The case shells, side panels and snap-in panels all have a strong clip together mechanism, without a single screw.

It is possible to customize the EURO CASE to your own corporate appearance by selecting the side panels and snap-in panels in your company's colors.

YOUR ADVANTAGES

Minimum amount of assembly required thanks to the special OKW snap-lock mechanism.

Injection-molded reinforcing ribs ensure that these conveniently light cases have a high degree of torsional resistance and rigidity.

Variable case heights (1 HE to 6 HE) for individual installation configuration – depending on space requirements.

Any problems in ventilation are solved by snap-in panels with ventilation slots.

MATERIAL / COLOR

Case shell, snap-in panel, tilt foot:

- ABS (UL 94 HB), off-white (RAL 9002)

Side panel:

- ABS (UL 94 HB), off-white (RAL 9002)
- ABS (UL 94 HB), people gray (RAL 7032)

Front panel:

- Aluminum, matt anodized

OUTSIDE DIM. IN INCHES

Type	W x D x H
42 TE	10.236 x 9.843 x 2.126-5.630
63 TE	14.449 x 9.843 x 2.126-10.886

PROTECTION CLASS < IP 40

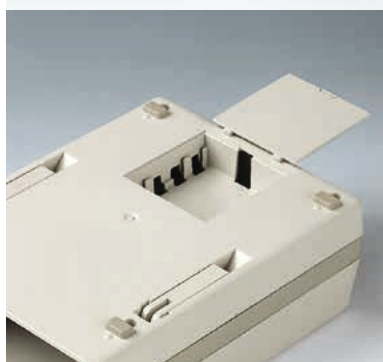
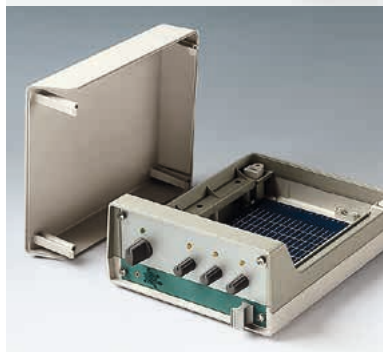
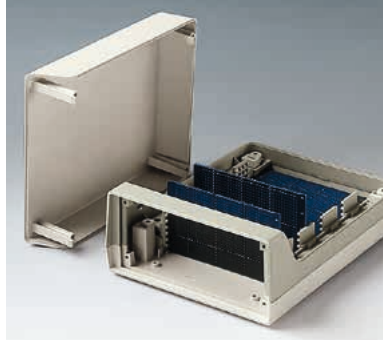

FAST ASSEMBLY

MATERIAL / COLOR

Bottom and top part, tilt foot:

- ABS (UL 94 HB), off-white (RAL 9002)

Middle section:

- ABS (UL 94 HB), pebble gray (RAL 7032)

Front panel:

- Aluminum, matt anodized

OUTSIDE DIM. IN INCHES

Type	W x D x H
150	4.646 x 5.906 x 2.244
190	5.827 x 7.480 x 2.638
230	6.811 x 9.055 x 5.354

PROTECTION CLASS < IP 40

YOUR ADVANTAGES

The LUX CASE range offers an unusual case design.

The three-part assembly makes the components easily accessible.

The selection of the center section, e.g. in your company's color, allows you to create individual electronics cases to match the corporate design of your company.

YOUR ADVANTAGES

Vertical and horizontal PCB mounting – a special advantage of the OKW LUX CASE range is achieved by the specially designed card guide. The card guide is fitted into the center section and can be moved horizontally.

The assembled PCBs can be simply inserted from the front. For this, the PCB is assembled with the front panel.

It is simple to use and the display instruments are easy to read off, thanks to the fold-out tilt feet or sturdy tilt bar (size 230 only). May also be used as a carry handle.

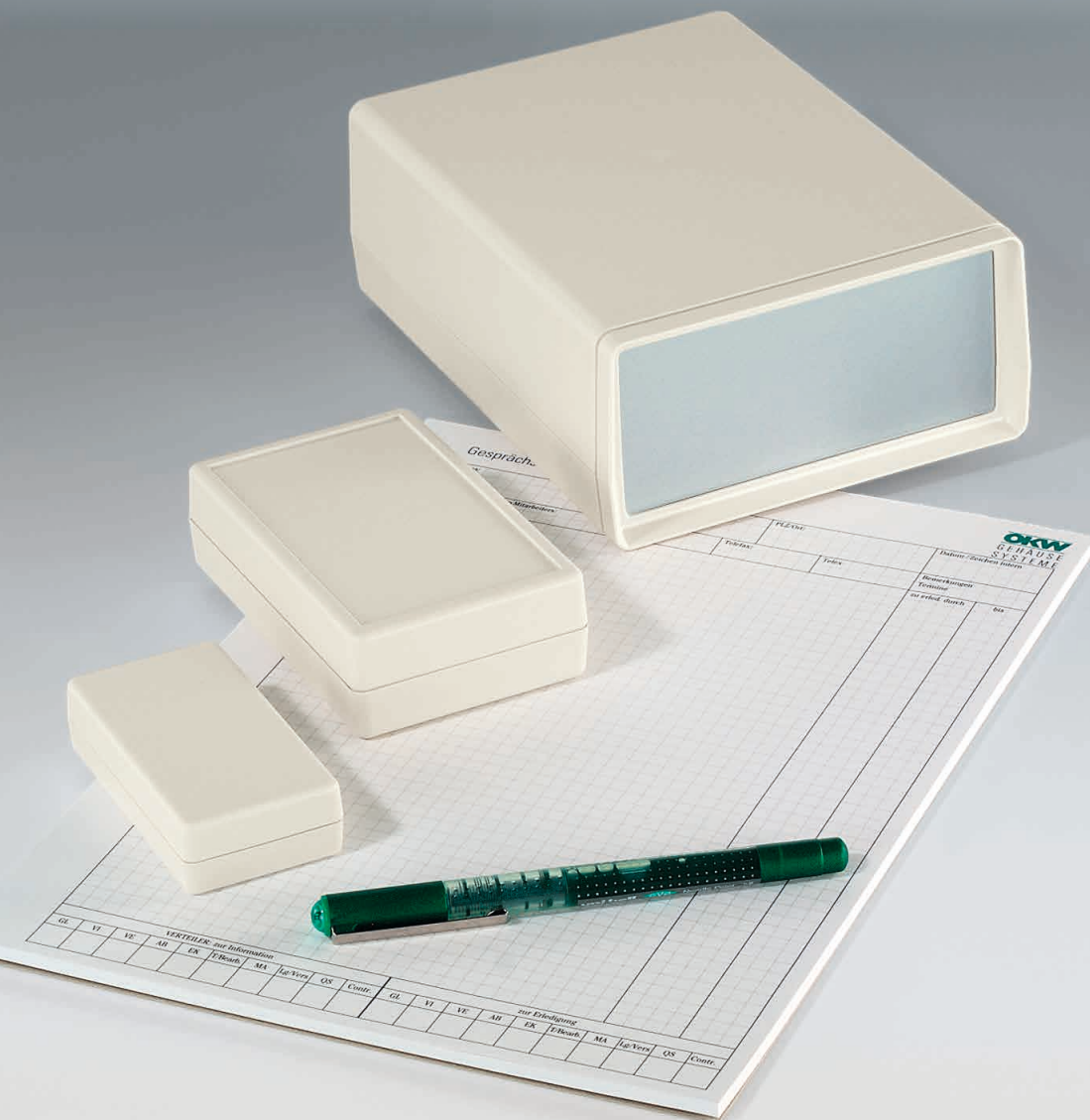

1001 POSSIBILITIES

THE PRODUCT

The comprehensive SHELL-TYPE CASE range is available in different sizes, heights and types.

Simply choose the case that meets your special requirements.

YOUR ADVANTAGES

A high degree of rigidity and tight fitting as a result of the tongue and groove joint.

Flat design for small-volume components.
Higher versions for larger components.

Guide ridges for vertical mounting of partitions and PCBs. Fastening pillars in top and base part.

On request the shell-type cases are also available with EMC aluminum metallisation. Contacting can be improved using the available contact strips (accessories).

MATERIAL / COLOR

Enclosure:

■ ABS (UL 94 HB), off-white (RAL 9002)

Front and rear panel:

■ Aluminum, matt anodized

■ PMMA, red (plexiglass®)

PROTECTION CLASS IP 65

For closed versions (G) without battery compartment when using the sealing kit (accessory).

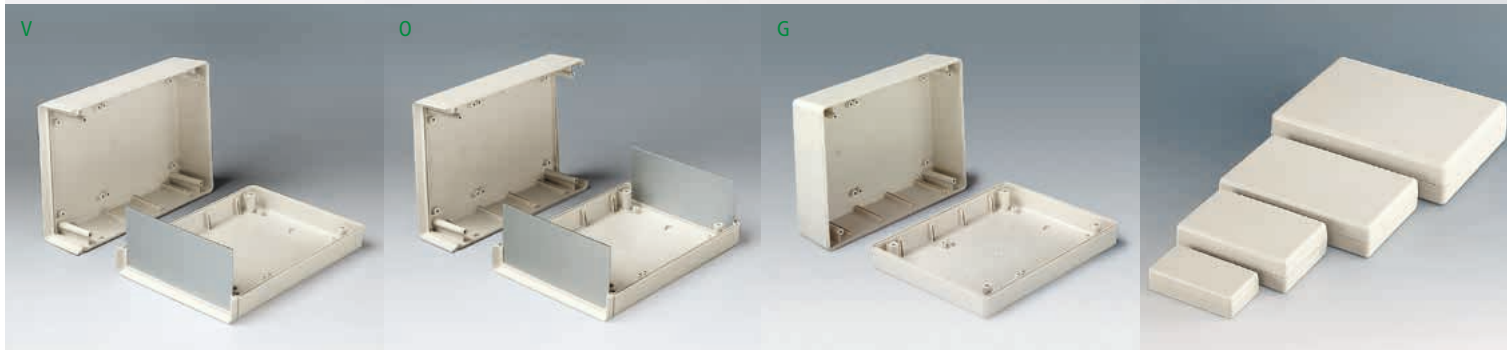

FUNCTIONALLY DESIGNED

OUTSIDE DIM. IN INCHES / TYPES

L x W	H	Types	Battery compartment*
3.346 x 1.772	0.866 1.299* 1.772*	V, G	-
4.488 x 2.835	1.30/1.32* 1.772 2.244	V, G	1x9 V
6.220 x 3.740	1.30/1.32* 1.772 2.244	V, O, G	2xAA/1x9 V 4xAA/2x9 V
7.480 x 5.433	1.77/1.79* 2.677 3.583	V, O, G	4xAA/2x9 V

*depending on case versions
 V = open front; O = open front, open rear;
 G = closed front, closed rear

YOUR ADVANTAGES

3 different case types:
 V: open front, closed rear.
 O: open front, open rear.
 G: closed front, closed rear.

Front and rear panels in aluminum or PMMA red (plexiglass®) available as accessories.

Without/with battery compartment.

Closed versions with flat top parts (type G), also with recessed area to protect the membrane keypad.

APPLICATIONS

Measuring and control technology.

Medical field and laboratory technology.

Peripheral devices and interfaces, switchboxes, modems.

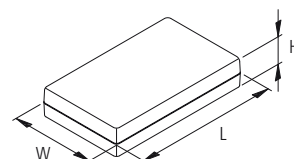

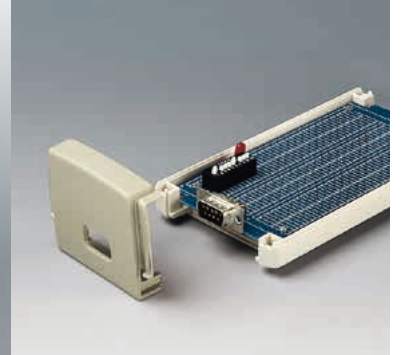

PROFESSIONAL ASSEMBLY

THE PRODUCT

Screwing cases together is a thing of the past – TOPTec makes it possible. The snap-in system really is revolutionary, since it does not only lead to savings in the assembly of the cases.

The PCBs can be fitted on both sides with interfaces that project beyond the actual width of the case. The previous assembly of the connectors on the case wall and the connection cable for the PCB can now be dispensed with.

YOUR ADVANTAGES

Aesthetic design for indoor applications as a desk top or wall mounting system.

Simple screwless case assembly.

Base part with lateral opening for quick and easy equipping from all sides.

For the first time electronic parts and interfaces can be installed as a complete package.

MATERIAL / COLOR

Bottom and top part:

■ ABS (UL 94 HB), off-white (RAL 9002)

End panels:

■ ABS (UL 94 HB), pebble gray (RAL 7032)

One-colored:

■ ABS (UL 94 HB), black (RAL 9005)



SECURELY HELD

OUTSIDE DIM. IN INCHES

TOPTEC	L x W x H
102	4.016 x 2.126 x 1.181
123 F	4.843 x 2.677 x 1.181
123 H	4.843 x 2.677 x 1.772
154 F	6.063 x 3.307 x 1.496
154 H	6.063 x 3.307 x 2.205
194 F	7.638 x 4.528 x 1.811
194 H	7.638 x 4.528 x 2.677

PROTECTION CLASS IP 40

YOUR ADVANTAGES

Ideal wall mounting without changing the case design due to hidden wall suspension element with snap-in locking device.

Easy assembly on DIN rails.

Removable end panels, available with or without ventilation slots.

High and flat top part.

Recessed control area to protect membrane keypads.

APPLICATIONS

Universal case for electronic and electro-technical devices. For example, for monitoring purposes as check instruments, signalling equipment and control systems, medical field and laboratory technology, computer peripherals, automation etc.

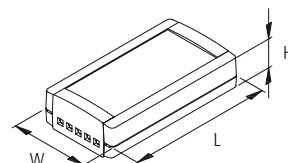

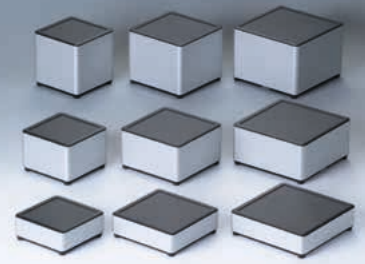

SQUARE (S)



ROUND (R)

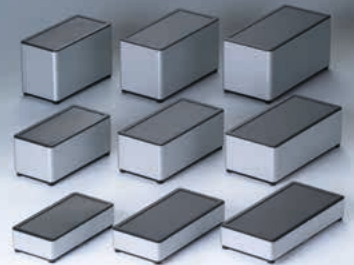

EDGE (E)



OVAL (O)

HARMONIOUS BLEND OF MATERIALS

THE PRODUCT

The name SYNERGY was chosen for the new range of products because the enclosure concept optimally combines the advantages of the attractive material combination of aluminum and plastic.

The purist enclosure design uses only the basic geometrical shapes of square, rectangular, circular and oval. The combination of three sizes for each basic shape, each in three different heights, means 36 enclosures which offer optimum protection as well as the sophisticated presentation of your electronics.

The aluminum frame has been blasted from all sides with glass beads, then anodized in silver, and picks up points for its exceptional stability and heat dissipation as well as its high quality appearance.

The ASA+PC-FR plastic used is characterized by high flame resistance and very good UV protection. The top and bottom parts, battery compartments/compartments lid, connecting parts and the optional wall mounting are made of reinforced polyamide.

MATERIAL / COLOR

- Plastic parts ASA+PC-FR black (RAL 9005)
- Aluminum profile AlMgSi 0,5 silver anodized

Corrosion-free stainless steel screws with reliable Torx drive for the enclosure and the battery compartment lid.



HIGH-QUALITY APPEARANCE

OUTSIDE DIM. IN INCHES

SYNERGY	L x W	H
S100	3.94 x 3.94	1.57/2.76/3.94
S120	4.72 x 4.72	1.57/2.76/3.94
S140	5.51 x 5.51	1.57/2.76/3.94
R100	Ø 3.94	1.57/2.76/3.94
R120	Ø 4.72	1.57/2.76/3.94
R140	Ø 5.51	1.57/2.76/3.94
E160	6.30 x 3.15	1.57/2.76/3.94
E180	7.09 x 3.54	1.57/2.76/3.94
E200	7.87 x 3.94	1.57/2.76/3.94
O160	6.30 x 3.15	1.57/2.76/3.94
O180	7.09 x 3.54	1.57/2.76/3.94
O200	7.87 x 3.94	1.57/2.76/3.94

PROTECTION CLASS IP 40

YOUR ADVANTAGES

36 enclosures with plenty of room for your electronics and your operating elements.

Recessed surface in the top part for decor foils or membrane keypads.

Non-slip enclosure feet cover the stainless steel screws and ensure stable positioning for desk-top applications.

Optional wall mounting as an accessory.

Battery compartment with battery clips as accessories, with 2/3 or 4 x AA, depending on the size of the enclosure.

Alternatively, AA and AAA battery clips or button cell holders as accessories to mount the batteries directly on the board.

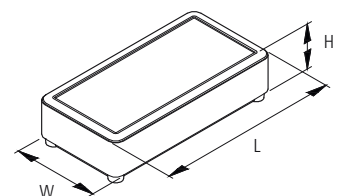

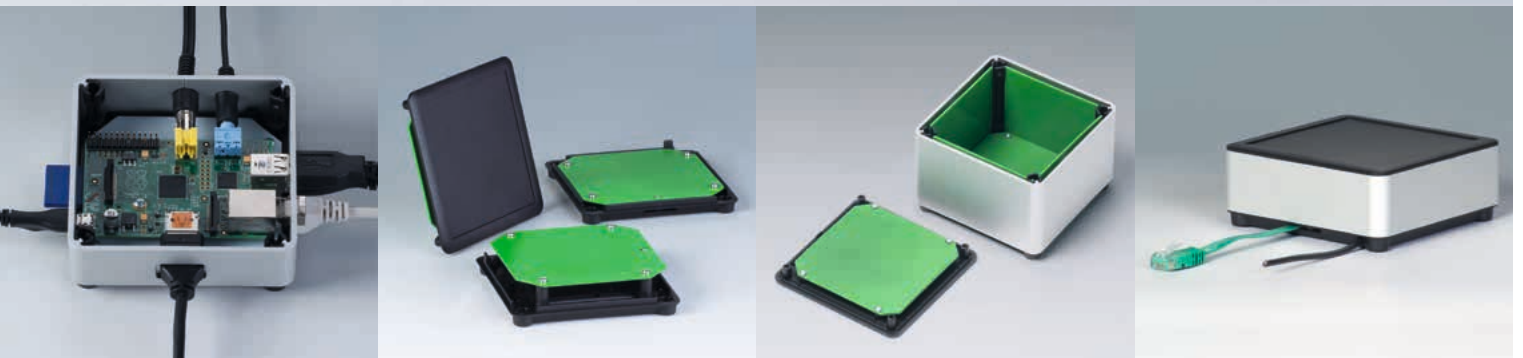

INSTALLATION PLANNING

YOUR ADVANTAGES

Plenty of surface space for interfaces, no inclined surfaces, easy assembly.

PCBs can be mounted in the top and bottom parts. Further mounting plates can be inserted at the side.

Extender kit to extend the board attachment pillars as an accessory. When there is a battery compartment in the bottom part, this makes it possible to mount a board above the battery compartment.

YOUR ADVANTAGES

Cables of up to $\varnothing 0.157''$ can be routed out of the bottom part through an additional hole, e.g. for charging cables.

Alternatively, a flat cable with a thickness of up to $0.059''$ can also be routed out of the cover, for example for a network connection. To do this, simply remove the narrow ridge on the cover.

Opening in the bottom part for the use of a battery compartment or for access to the interior, e.g. for a memory card or batteries that are mounted directly on the board.

ENCLOSURE SUPPLY

- 1 top part, bottom part and cover each.
- 1 Aluminum profile.
- 1 Assembly kit, consisting of
 - 4 non-slip enclosure feet,
 - 1 screw for the battery compartment lid,
 - 4 connectors and
 - 4 enclosure screws.



YOUR INDIVIDUAL ENCLOSURE

SPECIAL LENGTHS

Special lengths for aluminum frames available on request – in increments of 0.197".

Maximum length of the aluminum profile 11.811". This results in a maximum enclosure height of 12.205".

MODIFICATIONS AND FINISHING

On request we can do the following work for you:

Mechanical processing for your interfaces (aluminum and plastic).

Special coloring for the plastic parts from 1 piece.

Digitally printed foils & membrane keypads.

Individual lettering and printing.
Engravings.

Aluminum frame, anodized black.

APPLICATIONS

Data systems engineering.

Network technology.

Building services systems.

Safety engineering.

Medical and therapeutic applications.

Measurement and control technology,
and much more.

FLAT-PACK CASE



FAST AND SIMPLE MOUNTING

THE PRODUCT

OKW FLAT-PACK CASES represent low-priced housings for your electronics.

The bottom parts are open at the sides and are thus particularly useful for all installation and service work.

Different sizes, heights and versions make functional and practical applications possible.

TYPES

With low (N) and high (H) top part. Special version with handle bar for convenient canting or easy carrying.

With ventilation slots for components dissipating high heat (189 L).

With slots on the top part for miniature appliances with sound signal (120 S).

Screwless assembly with separate front panel in aluminum, easy machining. Control elements and lettering are protected through a raised edge on the case (type A).

MATERIAL / COLOR

Top part / bottom part:

- ABS (UL 94 HB), off-white (RAL 9002)
- ABS (UL 94 HB), pebble gray (RAL 7032)

OUTSIDE DIM. IN INCHES

Type	L x W	H
100 N/H	3.94 x 1.97	0.98 / 1.57
120 N/H	4.72 x 2.56	1.57 / 2.56
150 N/H	5.91 x 3.15	1.97/2.17/3.15
189 N/H	7.44 x 4.33	2.36 / 2.76 / 3.82 / 4.72
120 S	4.72 x 2.56	1.57
189 L	7.44 x 4.33	2.76
120 A	4.72 x 2.56	1.57
150 A	5.91 x 3.35	1.77
210 A	8.27 x 4.92	2.76

PLUG CASE



RELIABLE CONTACT

Simply and extremely functional solution for your electronics.

German version also with integrated socket.

Robust and impact-resistant. The ball-thrust hardness test is performed at 125°C.

Fastening pillars for the PCB mounting, suitable for self-tapping screws (set with 4 pieces supplied with the case).

Protection class < IP 40

MATERIAL

Flame-resistant material (UL 94 V-0).

COLOR

Top part off-white (RAL 9002),
Bottom part pebble gray (RAL 7032).

DIM. IN INCHES

	L x W x H
D	4.72x2.56x2.17
UK	4.72x2.56x1.57
F /	3.94x1.97x1.57
D	4.72x2.56x2.56

ART-CASE



ERGONOMIC

MATERIAL

Plug section in flame-resistant materials (UL 94 V-0).

COLOR

One-colored off-white (RAL 9002) or black (RAL 9005).

DIM. IN INCHES

ø 4.33 x 1.18
ø 4.33 x 1.50
4.33 x 3.94 x 1.50

With "level" or "inclined" bottom part for a user-friendly operating area – accessible and easily legible.

Euro plug module in accordance with DIN VDE 0620 part 101.

Available in "round" and "square" basic enclosure shapes.
Protection class IP 40

Fastening pillars for mounting PCBs.

ART-CASE LEVEL/INCLINED



R110



S110



O160



E160

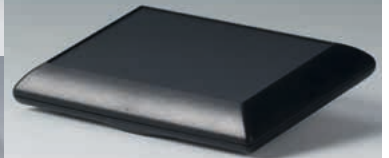

R110



O160



GEOMETRIC PERFECTION

THE PRODUCT

The ART-CASE series of cases with the basic shapes "round", "square", "oval" and "edged" sets new standards in design and function.

Different versions of the bottom and top parts as well as the base create interesting combinations and geometrical arrangements – for first-class visual impact!

LEVEL / INCLINED

Ergonomically shaped case design. Practical for operating and reading-off.

Base 30°/55° for different inclinations.

Flat top part with recessed operating area for the protection of the membrane keypad.

Available without/with battery operation. Battery compartment for 2 x AAA batteries as accessory or integrated supports for 2 x AA in the plain base.

MATERIAL / COLOR

- ABS (UL 94 HB), off-white (RAL 9002)
- ABS (UL 94 HB), black (RAL 9005)



FASHIONABLE CASE DESIGN

OUTSIDE DIM. IN INCHES

ART-CASE	L x W x H
R110 F "level"	ø 4.33 x 1.18
R110 H "level"	ø 4.33 x 1.50
R110 F "inclined"	ø 4.33 x 1.50
R110 H "inclined"	ø 4.33 x 1.61
S110 F "inclined"	4.33 x 4.33 x 1.50
O160 F "level"	6.30 x 4.33 x 1.18
O160 H "level"	6.30 x 6.30 x 1.50
O160 F "inclined"	6.30 x 4.33 x 1.50
O160 H "inclined"	6.30 x 4.33 x 1.61
E160 F "inclined"	6.30 x 4.33 x 1.50

PROTECTION CLASS IP 40

WALL / CEILING

Can be directly mounted to a wall/ceiling, or fitted using the accessory wall suspension element and a screw.

Various angles of inclinations of bottom parts and base versions provide an user-friendly operating area – within the operator's reach and easily legible.

The plain base serves as a spacer for ceiling/wall mounting and offers space for cable routing or 2 mignon cells 1.5 V (AA).

APPLICATIONS

Ideal for indoor electrical and electronic applications, e.g. for transmission and reception units in building services management systems and building installations.

Also in medical technology, computer peripherals, security technology etc.

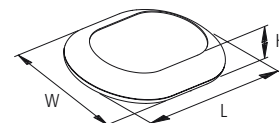



DESIGN IN HAND

MOBILE

The enclosure design with its rounded, gentle contours also favours hand-held enclosure applications.

YOUR ADVANTAGES

Available without/with battery operation. Battery compartment for 2 x AAA batteries as accessory. Easy accessible from the outside.

Flat top part with recessed operating area for the protection of the membrane keypad.

APPLICATIONS

All types of remote control devices, wireless or with cable.
 Digital control technology.
 Medical and laboratory technology.
 Building installations.
 Automation.



LOCKS ONTO DIN RAILS

MATERIAL / COLOR

Bottom part / top part:

- PPO (UL 94 V-0), black
- PC (UL 94 V-0), light gray (RAL 7035)

OUTSIDE DIM. IN INCHES

RAILTEC B	W x H x D
2 modules*	1.38 x 3.39 x 2.28
3 modules	2.05 x 3.54 x 2.28
4 modules*	2.76 x 3.39 x 2.28
6 modules*	4.13 x 3.39 x 2.30
9 modules*	6.18 x 3.39 x 2.30
12 modules	8.27 x 3.54 x 2.28
2 modules flat	1.38 x 3.54 x 1.22
4 modules flat	2.76 x 3.54 x 1.22
6 modules flat	4.13 x 3.54 x 1.22
9 modules flat	6.20 x 3.54 x 1.22

* VI version each 3.54" high

THE PRODUCT

The RAILTEC B family of cases features fast and simple locking onto standard rails complying with DIN EN 60715 TH35.

Different top parts make the case into a versatile and rational connection system.

NEW (see page 93):

- flat versions for the installation of large-area displays and operating elements
- cover for KNX connectors
- BUS system (acc.) for energy and data transmission in the DIN rail (0.295" height)

DIFFERENT TERMINATION OPTIONS EACH FOR COMMERCIAL COMPONENTS LIKE

- terminals
- PCB plug headers
- front connectors

When using terminals, the individual conductors can be connected and disconnected while the case is closed.

The connector lead avoids wiring faults when devices are exchanged during regular servicing.

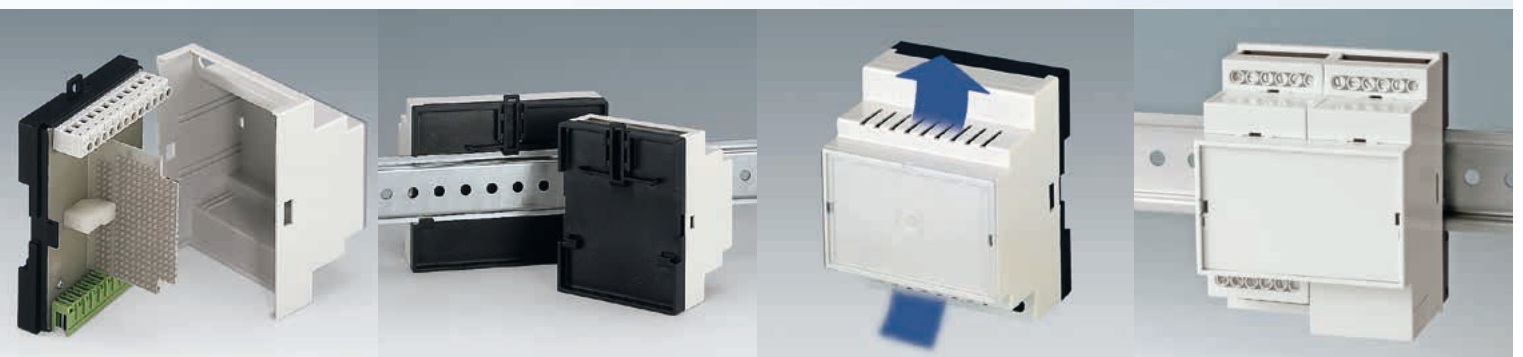

CONVINCING IN MANY WAYS

YOUR ADVANTAGES

6 sizes from 2 to 12 modules according to DIN 43880, size 1.

Suitable for DIN rails EN 60715 TH35 or direct wall mounting.

Flexible assembly. PCB positioning in all three directions: Base part with fixing pillars, top parts with guide ridges.

Locking clip preassembled in base part.

YOUR ADVANTAGES

Without/with ventilation slots for good heat dissipation.

Optionally 1 or 2 connection levels for case version VI; individual configuration with system components – according to need. Terminal guards in the higher versions give more room in the enclosures and a bigger surface to mill for bigger terminals.

Terminal blocks, plug headers, front panels etc. available as accessories for individual equipment.

APPLICATIONS

Universal use as installation case. Fully insulated and protected according to VBG4 as well as IEC 529/DIN VDE 0470-1. Corresponding to the regulations of the machine-building and motorcar industry. Especially for the control techniques.

NEW

RAILTEC B



FLAT VERSION / ACCESSORIES

NEW IN THE RANGE OF PRODUCTS

RAILTEC B with a flat top part in the widths 2, 4, 6 and 9 modules. Large-area displays and operating elements can be mounted directly on the attachment pillars in the top part. If required, the enclosures are also available with matching cutouts for your display and operating elements.

Cover for KNX connectors, to fit the RAILTEC B enclosure, version VI, or with flat top part in module widths 2 and 4. Easy snap-in installation.

MATERIAL/
COLOR

Top parts
PC (UL 94 V-0),
light gray (RAL
7035)

Bottom parts
PPO (UL 94 V-0),
black

MODULE DIM.
"FLAT" IN INCHES

	W x H x D
2	1.38 x 3.54 x 1.22
4	2.76 x 3.54 x 1.22
6	4.13 x 3.54 x 1.22
9	6.20 x 3.54 x 1.22

NEW

RAILTEC B/C

93

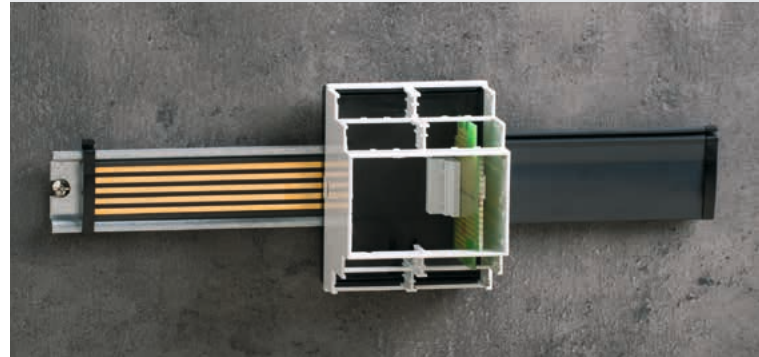

BUS SYSTEM

SIZES

9.842" long
19.685" long

NEW IN OUR PROGRAM

RAILTEC B bus system for energy and data transmission in the DIN rail (TH35 0.295" height).

Suitable for RAILTEC B (except flat versions) and RAILTEC C enclosures.

Gold-plated double contacts in the block of battery clips for reliable contact.

5 bus conductors.

Voltage up to 63 V, current up to 5 A for each bus conductor.



PERFECTLY COMBINED

THE PRODUCT

Comprehensive range of cases for DIN rail mounting as well as for direct wall mounting.

All types are extremely installation-friendly, for mounting components as well as for connection work!

YOUR ADVANTAGES

Suitable for DIN rails EN 60715 TH35 or direct wall mounting. Adapter for TH15 and G32 (1-4 modules) as accessory.

Outstanding material properties for tough conditions, with high temperature stability (UL 94 V-0).

Easy assembly with snap-in installation of the case parts.

DIFFERENT CONNECTION OPTIONS FOR COMMERCIAL COMPONENTS SUCH AS:

- terminals
- PCB plug headers
- front connectors

Connection possible from 1 side and/or 2 sides.

Terminal guards closed, perforated or with holes.

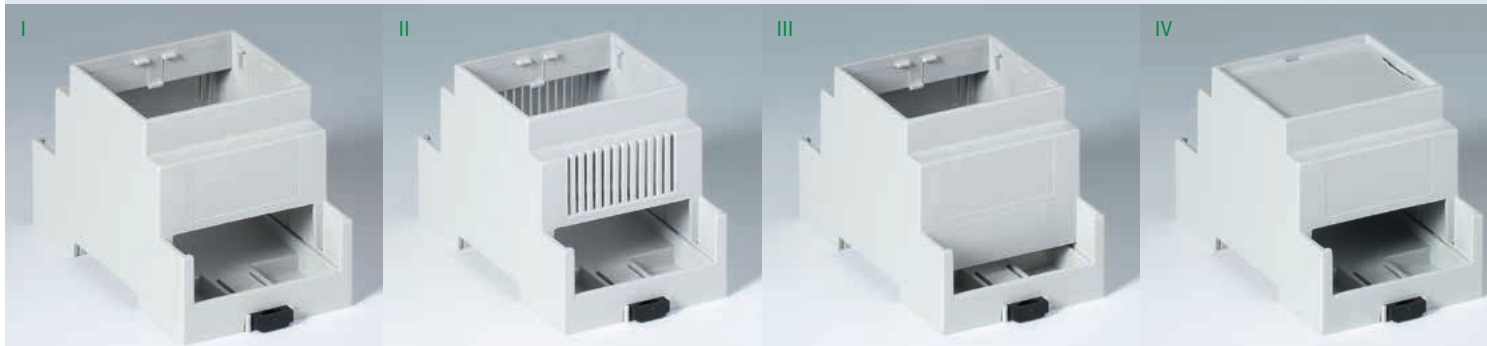
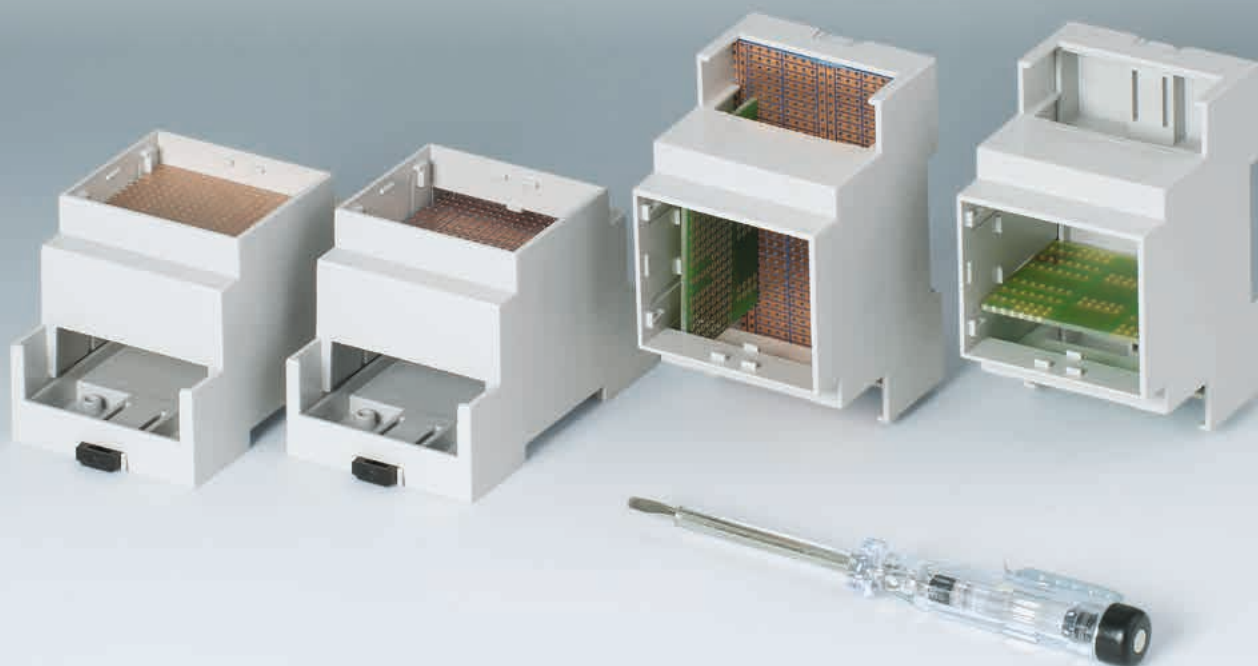

FLEXIBLE PCB ASSEMBLY

MATERIAL / COLOR

Bottom and top parts:

- PC (UL 94 V-0), light gray
- Locking clip black/translucent

SIZES IN INCHES

RAILTEC C	W x H x D
1 module	0.689 x 3.543 x 2.283
2 modules	1.417 x 3.543 x 2.283
3 modules	2.087 x 3.543 x 2.283
4 modules	2.795 x 3.543 x 2.283
5 modules	3.465 x 3.543 x 2.283
6 modules	4.173 x 3.543 x 2.283
	4.213 x 3.543 x 4.488
9 modules	6.299 x 3.543 x 2.283
12 modules	8.268 x 3.543 x 2.283

PROTECTION CLASS < IP 40

YOUR ADVANTAGES

Optional frame allows additional PCB position as well as the use of the hinged convex front lid.

Flexible assembly. PCB positioning in all 3 directions: base part with fixing pillars (except 1 module), top parts with guide ridges.

Front panels and front lids in different versions.

APPLICATIONS

Automation.

Building and safety technology.
Heating and air conditioning technology.

Especially suitable as an automatic control case for time controllers, sensors, relays, signal distributors, lighting controls etc.

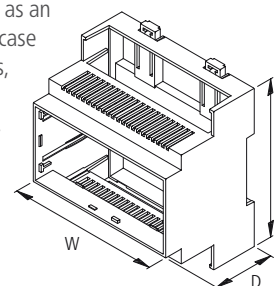



HIGH TOP PART

YOUR ADVANTAGES

Suitable for EN 50 60715 DIN rails as well as for direct wall mounting.

Bottom and top part PC (UL 94 V-0), light gray.

Printed circuit boards can be installed horizontally and vertically.

Openings for terminal outputs on both sides. Terminal guards available as accessories.

Open and closed front panels. Front panel and front cover available as accessories.

SIZE

Module width 6
with high top part

W x H x D in inches
4.21 x 3.54 x 4.49

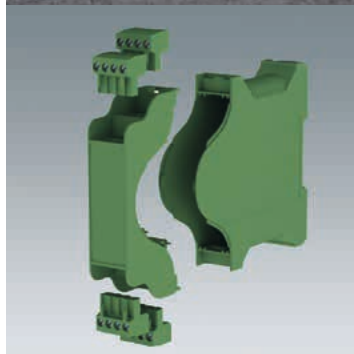
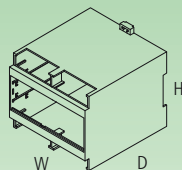

WITH CONNECTIONS

YOUR ADVANTAGES

Suitable for DIN EN 60715 rails.

With push-on terminal blocks, 16-pin
(4 x 4 pins) in a 0.197" grid.

Guide rails for vertical PCB slot.

Available with/without ventilation
slots for good heat dissipation.

Flame-resistant material PA66
(UL 94 V-0), green.

SIZE

W x H x D in inches
0.91 x 3.94 x 4.45

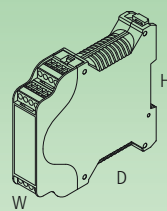

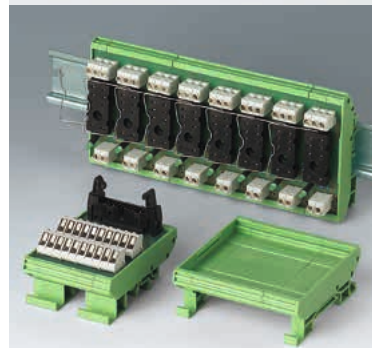
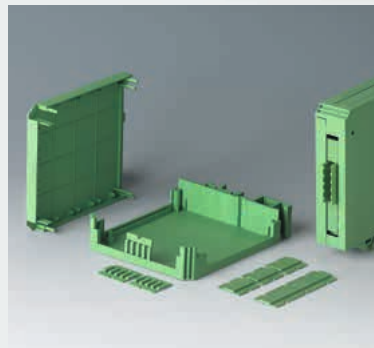
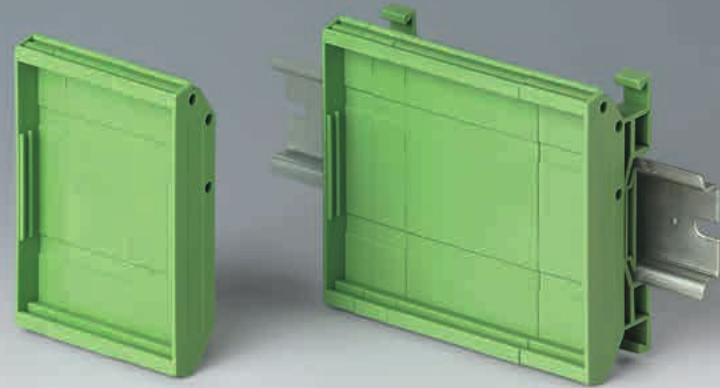

FOR PLUG HEADERS

PCB CHASSIS

YOUR ADVANTAGES

Suitable for EN 60715 TH35 and G32 DIN rails.

Connections possible on 3 sides.

For plug headers (ideally 0.197" pitch, max 12 pin). Unused terminal areas can be closed with push-in side walls, either with ventilation slots or without.

Flame-resistant material PA 6 (UL 94 V-0), green.

SIZES

W x H x D in inches

0.89 x 3.23 x 3.54

1.79 x 3.23 x 3.54

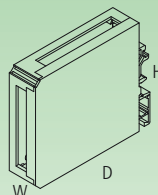

SIZES

2.835" wide PCB

4.213" wide PCB

Modular design.

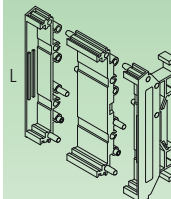

YOUR ADVANTAGES

Suitable for EN 60715 TH35, TH15 and G32 DIN rails or direct wall mounting with wall suspension element.

More flexibility through simple replacement of the interfaces.

Modular design for individual component mounting.

Flame-resistant material PA 6 (UL 94 V-0), green.

RAILTEC CM

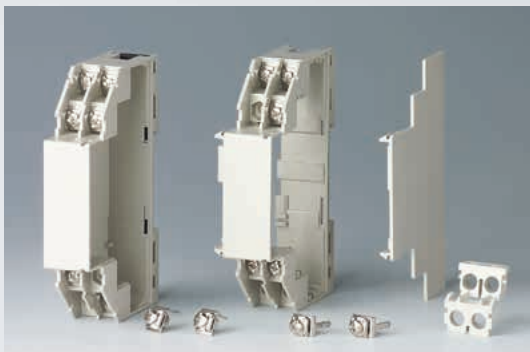

WITH CONNECTIONS

YOUR ADVANTAGES

Suitable for EN 60715 TH35 DIN rails. Adapter for TH15 and G32 as accessory.

Integrated connection system:
8 connections each on four levels;
for cable cross-sections of max.
2 x 2.5 mm² rigid or stranded
conductor design (ring eyelet/cable
lug/flat connector).

1 module (0.689") width, expandable
in 1 module increments with interme-
diate frame.

Flame-resistant material ABS
(UL 94 V-0), gray.

SIZE

W x H x D in inches
0.71" x 3.50" x 2.13"

Modular
expandable.

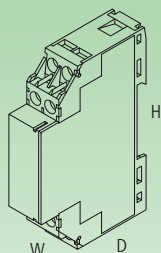

RAILTEC CC

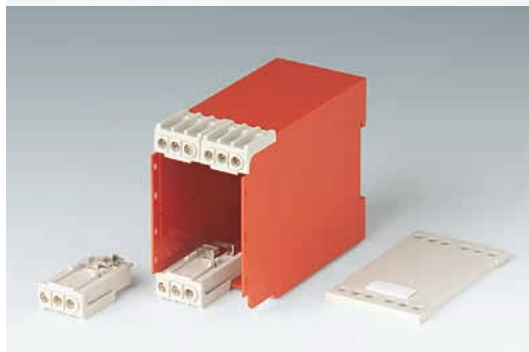
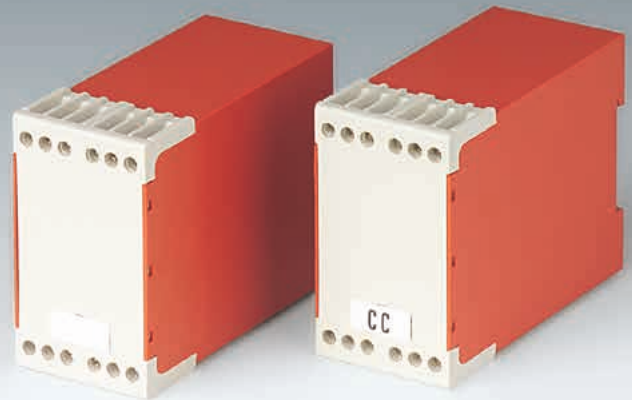

WITH CONNECTIONS

SIZE

W x H x D in inches
1.77" x 3.07" x 3.90"

YOUR ADVANTAGES

Suitable for EN 60715 TH35 DIN rails.
Adapter for TH15 and G32 as accessory.

Integrated connection system:
12 connections per case; for cable
cross-sections of max. 2 x 2.5 mm² rigid
or 2 x 1.5 mm² stranded conductor
design; PCB pins reduce the work
involved in wiring.

Removable front with integrated clips
for labelling.

Flame-resistant material PC (UL 94 V-0),
Front gray/enclosure orange.

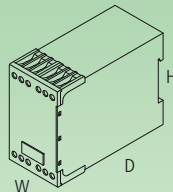

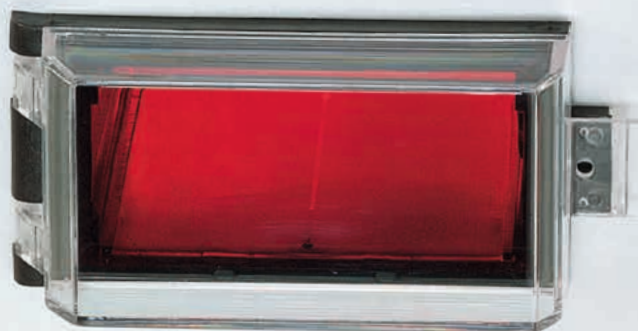
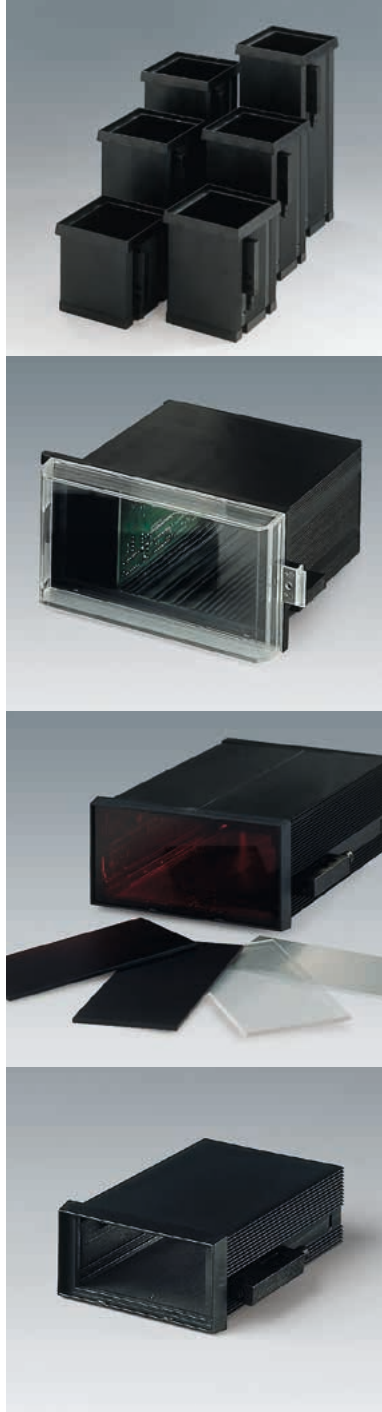

RATIONAL LOCKING ASSEMBLY

MATERIAL / COLOR

Enclosure:

- Noryl (UL 94 V-0), black

Front panel:

- Aluminum, matt anodized
- Noryl (UL 94 V-0), black
- Plexiglass transparent
- Plexiglass red transparent
- PC permeable to infra-red light

Rear panel:

- Aluminum, matt anodized
- Noryl (UL 94 V-0), black (except 5.670 x 5.670)

PROTECTION CLASS < IP 40

THE PRODUCT

The DIN-MODULAR CASES TYPE A differ from conventional systems for mounting control panels complying with DIN IEC 61554 through simple, screwless assembly of all case parts. This reduces production work and expenditure to a minimum.

Fastening elements for mounting the control panels are supplied with the case.

A further advantage of this design principle is the implementation of optional case lengths to match the application exactly.

YOUR ADVANTAGES

Material corresponds to UL 94 V-0: self-extinguishing and shock resistant. High standard of mechanical and electrical properties.

7 different standard dimensions: 2.835" x 1.417", 1.890" x 1.890", 3.780" x 1.890", 2.835" x 2.835", 3.780" x 3.780"*1, 5.670" x 2.835"*1, 5.670" x 5.670". Enclosure depth from 2.244" - 7.047" (depending on type).

PCBs are fixed in place by the rear frame.

*1does not correspond exactly to DIN IEC 61554

DIN-MODULAR CASES TYPE B

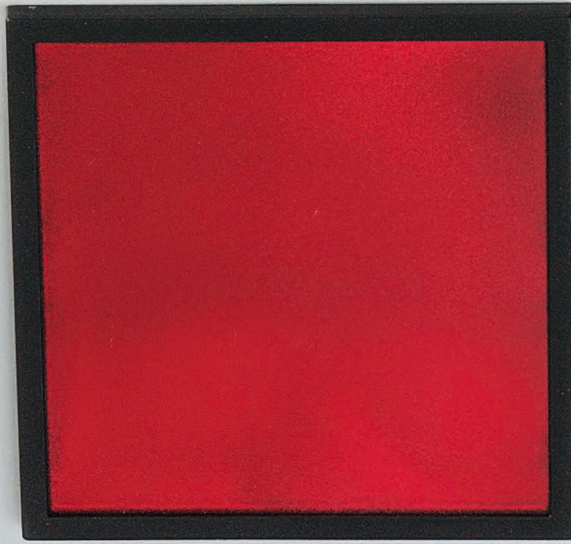

MOUNTING OF PCBs FROM THE FRONT & ABOVE

THE PRODUCT

DIN-MODULAR CASES TYPE B are available in three different designs for mounting control panels complying with DIN IEC 61554.

DESIGNS

Design 1
For horizontal slide-in mounting of PCBs from the front. Closed cases with removable front frame and rear panel. Norm dimension: 3.78" x 1.89", 2.84" x 2.84", 3.78" x 3.78"

Design 2
Versions with separate lids allow vertical and horizontal slide-in PCB assembly. Norm dimension: 5.67" x 2.83", 5.67" x 5.67"

Design 3
same as design 2, but particularly designed for 19"-system slide-in assemblies 12 TE, 3 HE). 2.83" x 5.67".

DESIGN 1

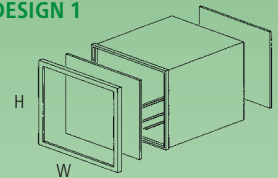

DESIGN 2

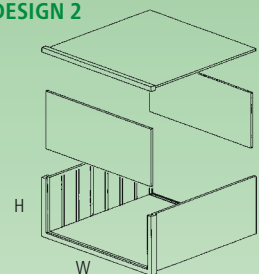

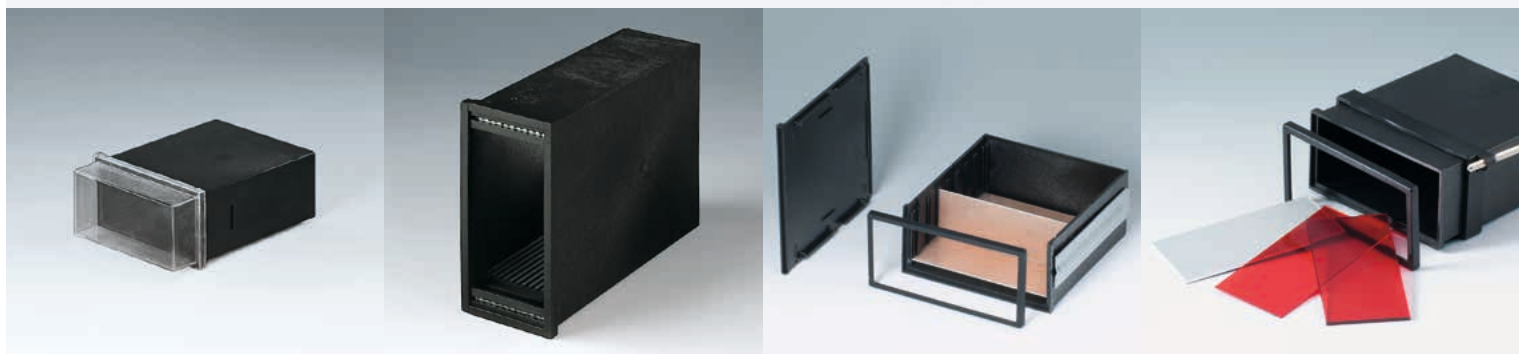

MULTIPLE APPLICATIONS

MATERIAL / COLOR

Enclosure:

- Glass fiber reinforced Noryl (UL 94 V-1), with outstanding mechanical and electrical properties, black

Front panel:

- Aluminum, matt anodized

Filter plate:

- Acrylglas, red transparent
- SAN (UL 94 HB), red transparent (depending on enclosure)

PROTECTION CLASS < IP 40

YOUR ADVANTAGES

All components including the electronic parts can slide into the case from the front side resp. from above, dependent of the case design.

The rear panel has fixing ribs to hold PCBs and slots for the plug connectors.

Holder or bracket for secure mounting within the control panel.

Transparent snap-in cover (accessory) protects displays and operating elements (3.780" x 1.890" – 5.670" x 2.835").

APPLICATIONS

Case system for a multiple applications.

Especially suitable for measuring, control technology and remote controls.

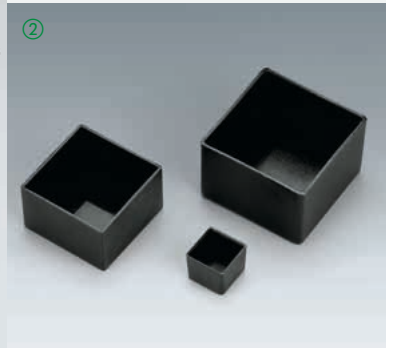
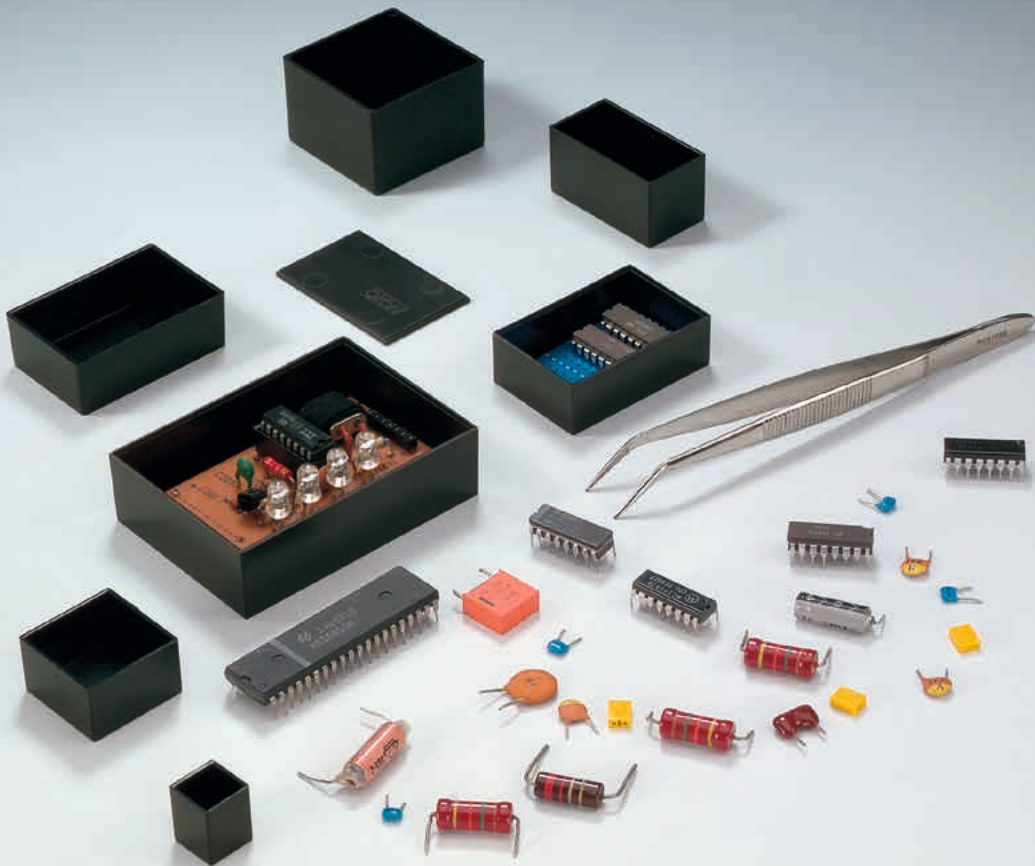

FOR EASY ENCAPSULATION

THE PRODUCT

OKW POTTING BOXES – a comprehensive range of boxes for potting electronic assemblies. With special cost advantages for series-type production.

Potted assemblies are protected from shock as well as temperature, dampness and chemical influences. The versions made of Duroplast are less resistant to impact than the Polyamide 6.6 or ABS models.

YOUR ADVANTAGES

Duroplast (①)
Resistant to deformation and extreme temperatures.

Polyamid 6.6 (②)
Good value for money. High-impact.

ABS (③)
Good value for money. Preferably for potting small assemblies.

MATERIAL / COLOR

- Duroplast, black
- PA 6.6, black
- ABS, black

OUTSIDE DIM. IN INCHES

Type	L x W x H
Duroplast	0.79 x 0.79 x 0.52 – 3.94 x 3.94 x 1.57
PA 6.6	0.55 x 0.55 x 0.45 – 1.82 x 1.82 x 1.61
ABS	0.48 x 0.48 x 0.60 – 2.66 x 1.41 x 1.82

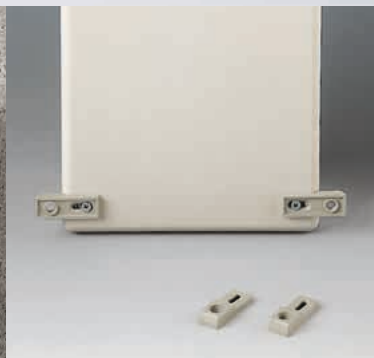
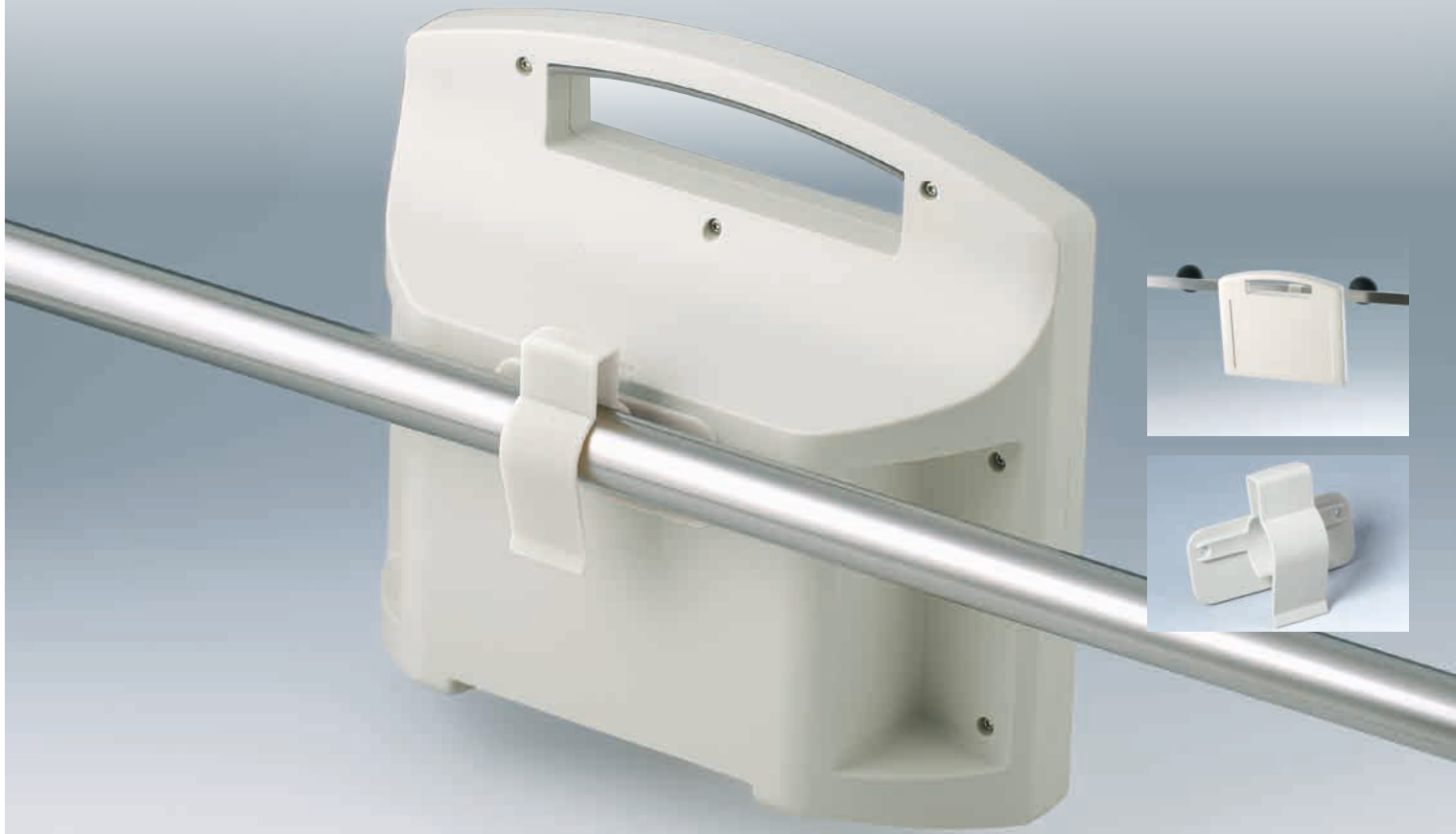

SECURELY HELD

RATIONAL HINGE AND LOCKING TECHNIQUES

For easy opening
of the devices.



THE PRODUCT

OKW offers you a comprehensive range of ACCESSORIES. Adapted to the application, our standard cases can thus be modified in many different ways.

OKW ACCESSORIES are designed to be practical, thus providing you with more flexibility for your individual case.

Here, too, numerous solutions show our high propensity to innovate.

WALL / RAIL

Wall suspension elements for hidden or external wall mounting.

Holding clamp for round tubes or standardized rails.

Fastening elements for DIN rails according to DIN EN 60715 TH35 and G32.



ERGONOMIC & RELIABLE POSITIONING

HOLDING DEVICE

Holding devices for universal use. With ball joint, flexible swan neck, for bicycle assembly or with suction pad. Horizontal and vertical tilt angle, ergonomically inclined for the operator. Suitable adapter for the enclosures as accessory.

POSITIONING

Tilt foot bar resp. handle bar facilitates desktop applications ergonomical inclination angle. This facilitates viewing of displays as well as operating.

Case feet ensure reliable positioning. Versions with tilt legs provide ergonomic inclination angle.

HANDLE BAR IN DIFFERENT MATERIALS

Side arms made of polyamide with aluminum profile.

Side arms made of diecast zinc for high load with aluminum profile.

Individual profile lengths (suitable profile separately on demand).

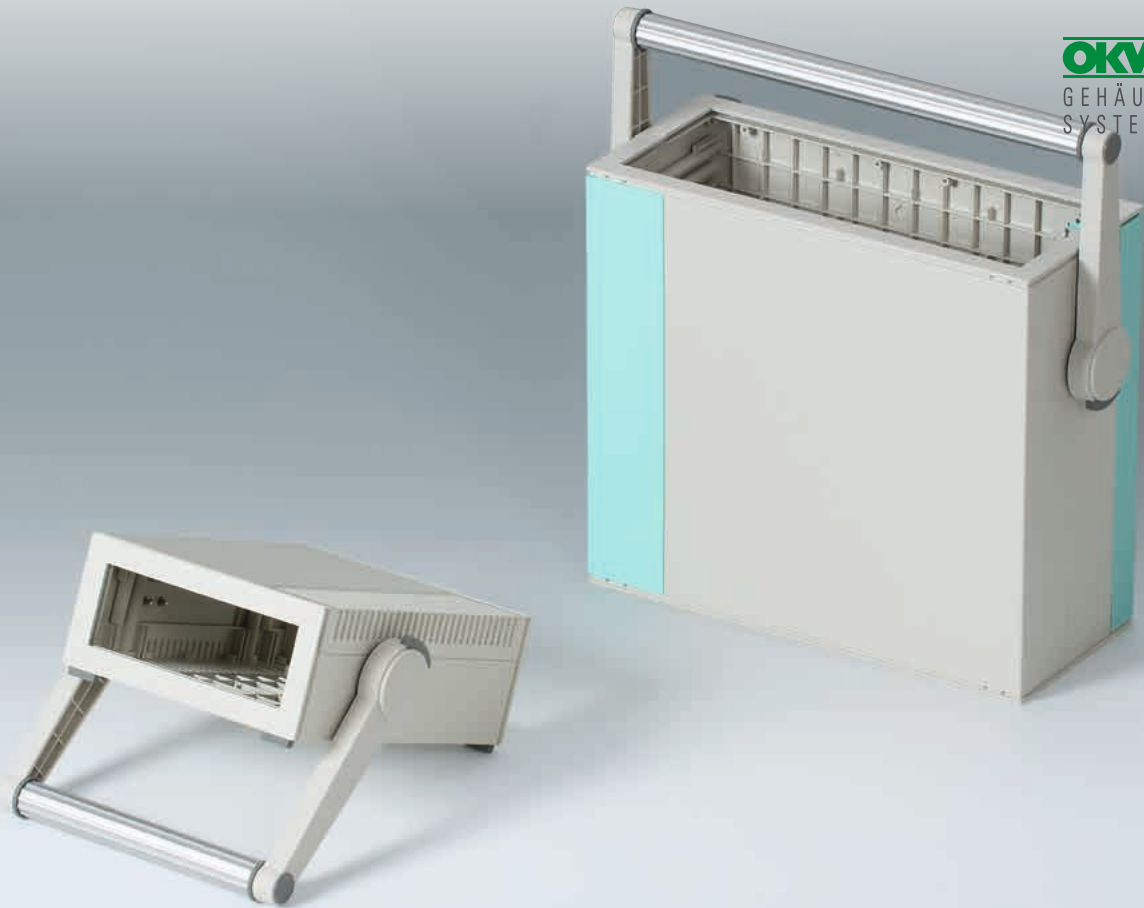

ON THE WAY



**MORE
COMFORT
IN USE**

MOBILE

For mobile use, the enclosures can also be combined with a carrying handle. This allows a secure grip as well as ergonomic handling above the center of gravity of the enclosure. If necessary, the adjustment mechanism also allows the user to set a practical angle in situ, in increments of 30°.

MOBILE

Practical belt / pocket clip for attaching small plastic enclosures to shirts and belts.

Lanyard, belt strap with clip-on or push-on connection and wrist strap as individual supplements.

Ring eyelets for threading hand straps and the like, simple installation with snap-in hook.



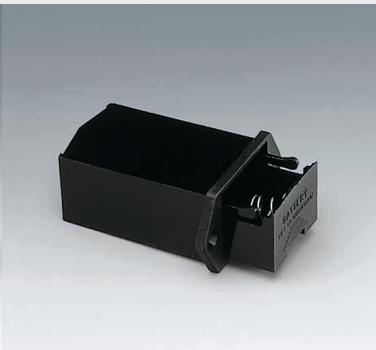

INTERNAL POWER SUPPLY

BATTERY COMPARTMENTS

Battery compartments and holders in different versions and types for direct installation in front and rear panels or enclosure walls. Easy battery replacement.

Battery holder, battery clips and button cell holder with connector pins for mounting on PCBs.

CONTACTS

Plug-in contacts with lateral or T-shape cable connection suitable for 9 V flat battery.

Wide choice of battery clips, in different materials for OKW battery compartments – single pieces or supplied as sets.

BATTERY SPACER

For taking up the gap when fitting AA cells instead of a 9 V flat battery in the battery compartment.



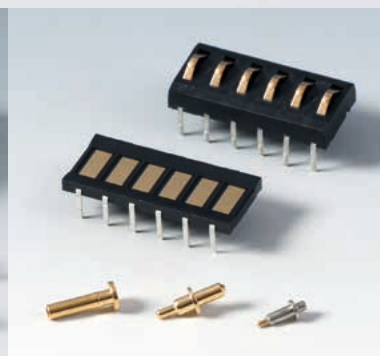

CONNECTIONS

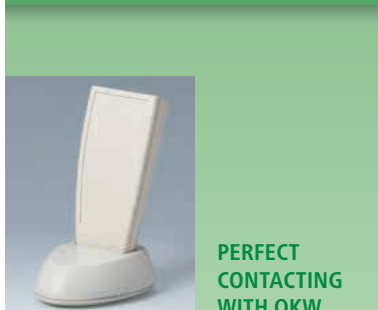

PERFECT CONTACTING WITH OKW ENCLOSURES

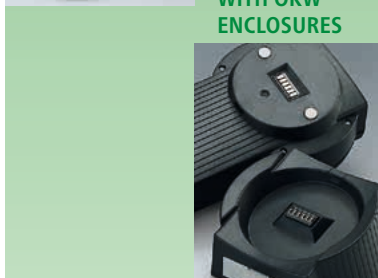

CABLE CONNECTION

Universally applicable cable glands for different cable cross-sections as kink protection and attractive closing point.

Wide choice of cable glands with strain relief of the best material for shake and twist-proof cable lead-in. The sealing ring for external thread preserves the high protection class IP 68.

Optionally available strain relief protects cable connections from mechanical stress.

INTERFACES

Pressure compensation element with particularly high air flow to protect sensitive electronics in case of changing weather conditions. Also suitable for large-volume protective cases and control cabinets. High protection rating IP 56.

USB end cover for connector types A according to DIN IEC 61076-3-107 and Mini-USB.

Contacts for transmission of data and charging current. NEW: Also available as kit with mounting plates for simple installation.

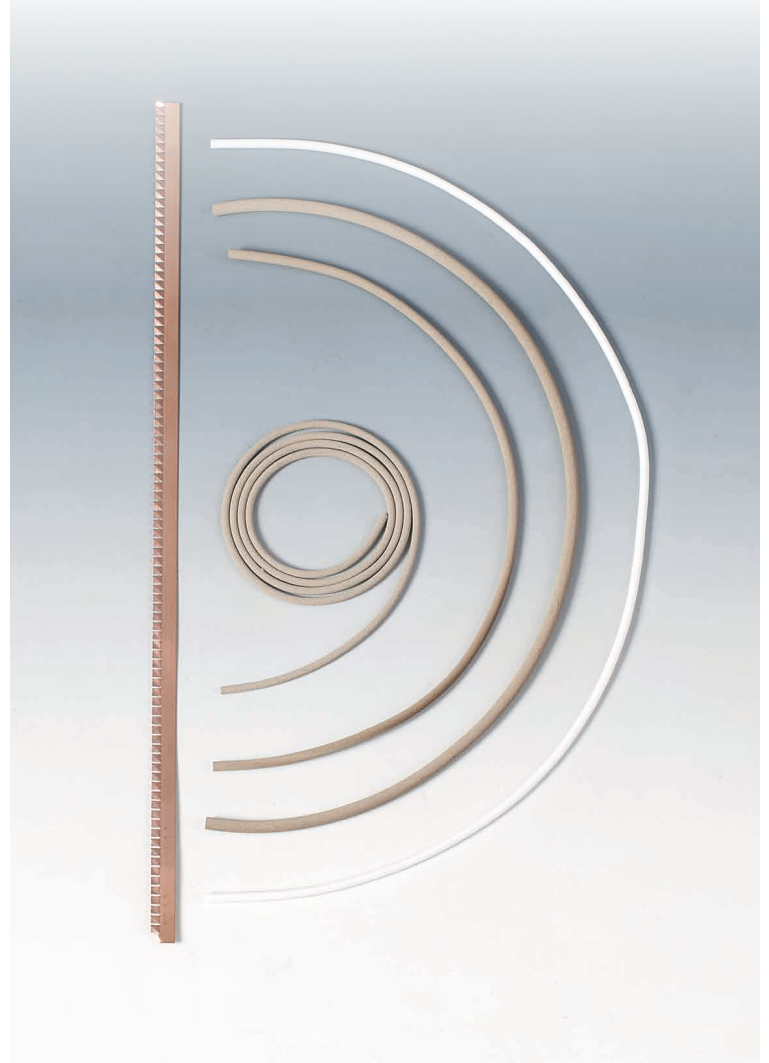

STANDARD RANGE OR CUSTOMER-SPECIFIC

PLASTIC AND ALUMINUM PANELS

On request we can also supply blanks made of plastic and aluminum in individual sizes and shapes or finished parts according to customers' drawings.

We can offer high-quality plastic and aluminum panels in different colors, panel thicknesses and surface textures, depending on the material.

DISPLAY WINDOW

In addition to our standard display windows, we can also supply blanks in all sizes or finished parts according to customers' drawings.

Different materials:

- Antiflex one-sided anti-reflection surface to avoid undesired light reflections
- Lux-Acryl transparent
- PC transparent or transparent V-0 (Europlex F7)

EMC PRODUCTS

If required we can supply conductive seals in individual sizes from \varnothing 0.059" – 0.118" as well as contact strips to improve the electromagnetic compatibility (EMC) of shielded enclosures. Why not ask us!

To shield electronic equipment against radiation from outside as well as from increased internal emission noise, we can vapour-plate with aluminum the inside of plastic enclosures and partial covers that offer no natural protection from electromagnetic radiation, see page 127.



COMPLETE YOUR DEVICE

SMALL PARTS

Self-tapping screws for fastening components, boards and PCBs with crosshead (PZ1) or Torx (T10).

For individual mounting and configuration, we can offer a wide range of fasteners, e.g. threaded bushes and bolts, spacers, mounting pillars, screws etc.

MOUNTING

We will also be pleased to perform the necessary modifications and all assembly work to complete your device.

Assembly of enclosure accessories, e.g. cable glands, belt / pocket clips, tilt foot bars, wall mountings, hinges, handle bars and much more.

Application of keypad foils, decor foils, type plates, display windows etc.

Adhesive foils in any shape for application.

Mounting of assemblies, installation of components.

Assembly and packaging to customer's specifications, e.g. soldering for battery contacts, wiring, connections, seals, conductive seals, contact strips etc.





INNOVATIVE TECHNOLOGY & CONTEMPORARY DESIGN

“TUNING KNOBS
FOR ATTRACTIVE
DEVICE DESIGN.”

STAR-KNOBS FLUSH-FITTING



LUMINOUS CONTROL

THE PRODUCT

One could not have chosen a more suitable name, for the STAR-KNOBS – like the stars in the sky – they represent the visual highlights of your equipment.

The illumination guides the user to the central user interface and also gives impressive emphasis on innovative equipment design.

The STAR-KNOBS are available flush-fitting or surface-mounted.

APPLICATIONS

For rotary potentiometers or rotary pulse generators with round shaft ends in accordance with DIN 41591, including touch function.

Measuring and control technology.

Medical field and laboratory technology. Wellness.

Heating and air conditioning.

Communication. Building.

MATERIAL / COLOR

Knob:

- PA, volcano
- PA, nero
- PC, diamond (individual illumination)
- PC, ruby (can be illuminated)
- PC, emerald (can be illuminated)
- PC, sapphire (can be illuminated)

Cover / recess:

- PA, volcano
- PA, nero

FASTENING

Tried and tested collet fixture system with secure fit on the axle.

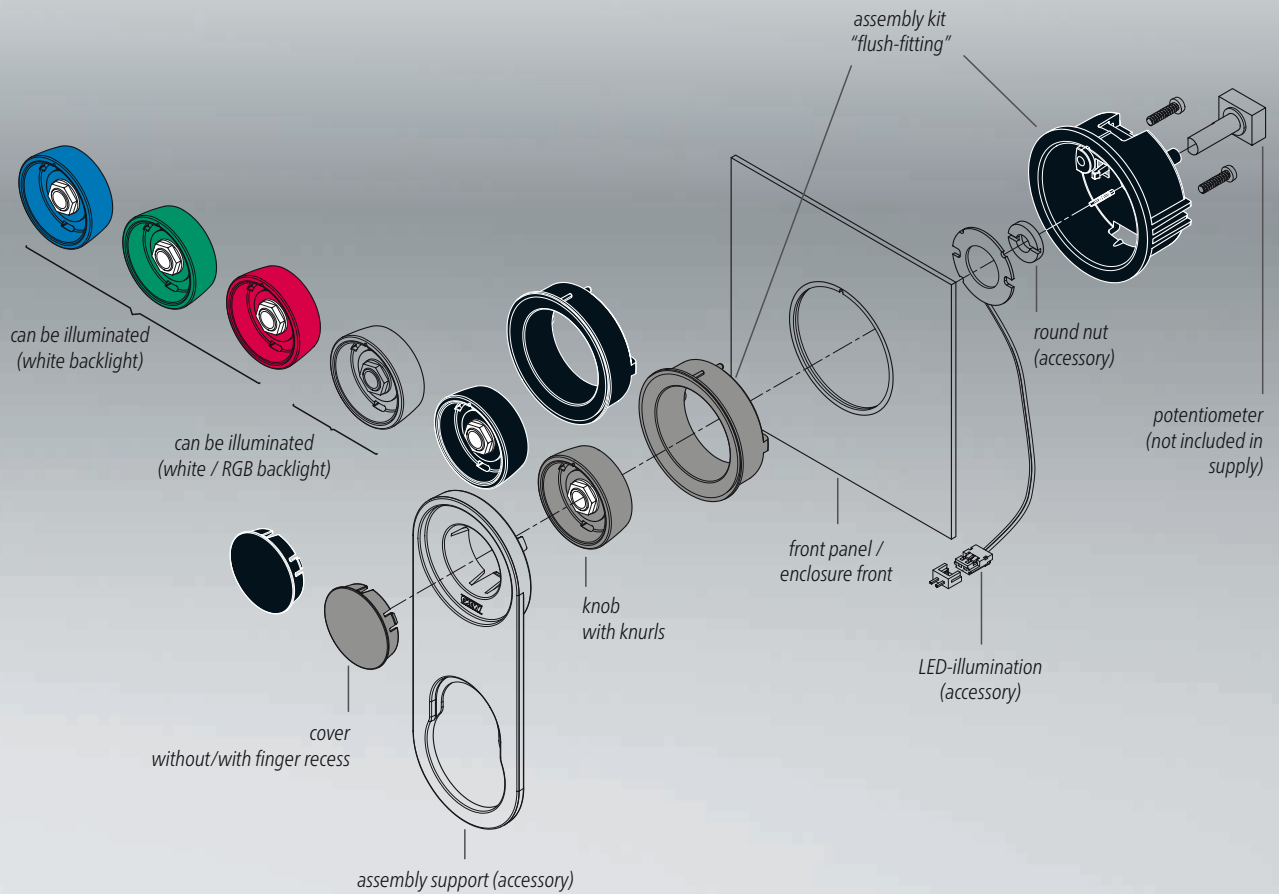

FLUSH-FITTING

DIM. IN MM

ø 33 (holes 6 mm and 1/4")
ø 41 (holes 6 mm / 8 mm)

BACKLIGHT

Optional illumination possible with modern, energy-saving SMD LED technology.

With **white backlight** you can realize the colors diamond, ruby, emerald and sapphire.



For individual colors there is a **RGB backlight** available. In this way you can display your own color.

FLUSH-FITTING

The flush-fitting installation in the built-in version of the STAR-KNOBS represents an attractive transition from the knob to the front of the device.

Your advantage: there are no projecting operating elements that can be actuated unintentionally.

The finger recess in the cover as well as knurls on the knob guarantee ergonomic operation.

An assembly support for mounting and adjustment is available as an accessory.

ILLUMINATION

With the **flush-fitting version** the knob can be illuminated, that is, a ring lights up between the recess and the knob cover.

For this please order **the translucent knob**.

The suitable PCB with LED illumination is available as accessory: white / RGB backlight.

STAR-KNOBS SURFACE-MOUNTED



LUMINOUS CONTROL

THE PRODUCT

One could not have chosen a more suitable name, for the STAR-KNOBS – like the stars in the sky – they represent the visual highlights of your equipment.

The illumination guides the user to the central user interface and also gives impressive emphasis on innovative equipment design.

The STAR-KNOBS are available flush-fitting or surface-mounted.

APPLICATIONS

For rotary potentiometers or rotary pulse generators with round shaft ends in accordance with DIN 41591, including touch function.

Measuring and control technology.

Medical field and laboratory technology. Wellness.

Heating and air conditioning.

Communication. Building.

MATERIAL / COLOR

Knob / ring (assembly kit) :

- PA, volcano
- PA, nero
- PC, diamond*
- PC, ruby*
- PC, emerald*
- PC, sapphire*

*ring can be illuminated

Cover:

- PA, volcano
- PA, nero

FASTENING

Tried and tested collet fixture system with secure fit on the axle.

For ordering information, drawings and 3D models visit www.okwenclosures.com

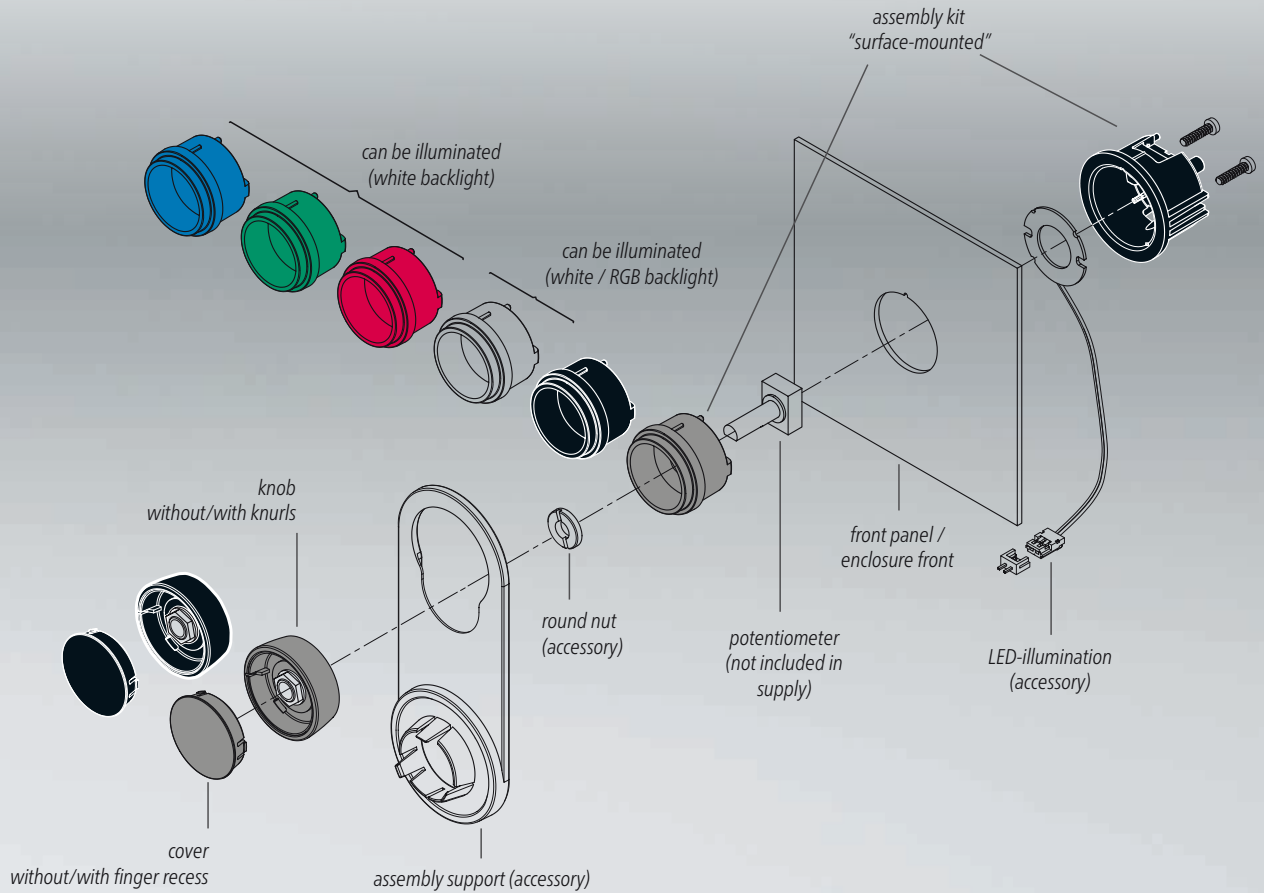

SURFACE-MOUNTED

DIM. IN MM

ø 33 (holes 6 mm and 1/4")
ø 41 (holes 6 mm / 8 mm)

BACKLIGHT

Optional illumination possible with modern, energy-saving SMD LED technology.

With **white backlight** you can realize the colors diamond, ruby, emerald and sapphire.



For individual colors there is a **RGB backlight** available. In this way you can display your own color.

SURFACE-MOUNTED

With the surface-mounted version, the knob design makes a great impression thanks to the slight inclination of the body towards the inner axis, thus allowing ergonomically favourable operation.

An assembly support for mounting and adjustment is available as an accessory.

ILLUMINATION

With the **surface-mounted version**, the knob is mounted on an approx. 3 mm high ring, which can be illuminated if required.

For this please order the **translucent assembly kit**.

The suitable PCB with LED illumination is available as accessory: white / RGB backlight.



DESIGNER KNOBS

THE PRODUCT

Our TOP-KNOBS are incomparable in design and are thus the ideal solution for all users looking for that special something.

By selecting a marking element geared to the application, you define the function of the tuning knob and at the same time give your equipment a modern, contemporary appearance.

The invisible screw-type fixture gives your equipment a pleasing and modern appearance.

YOUR ADVANTAGES

Aesthetically pleasing knob design.

The fixing technique rules out any possibility of contact with live parts.

Functional marking elements, e.g. for fine calibration. Easy to fit.

In connection with rotary potentiometers, the arrangement of the axis is recessed in order to accommodate external nuts and to make sure that the knobs form an even line with the front panel.

MATERIAL / COLOR

Knob:

● PA 6, volcano

● PA 6, nero

Marking element – depending on type –

● ● ● ● ● PA 6

DIM. IN MM

Ø 16, Ø 20, Ø 24, Ø 31, Ø 40

FASTENING

With lateral screw fixing on shaft ends according to DIN 41591

Pinned onto the axes with flattened shaft ends \varnothing 6/4.6 mm.



MODERN APPEARANCE

MATERIAL / COLOR

Knob:

- PA 6, volcano
- PA 6, nero

Cover / marking element:

- PA 6

DIM. IN MM

Ø 16, Ø 20, Ø 23, Ø 31, Ø 40, Ø 50

FASTENING

Tried and tested collet system for rotary potentiometer with round shaft ends conforming to DIN 41591.

THE PRODUCT

Outstanding appearance is a characteristic of the COM-KNOBS.

Aesthetic design and a modern selection of colors in pastel tones give your equipment a high quality appearance.

Different sizes and combinations also provide a wide selection of attractive tuning knobs with the tried and tested collet fixture system.

YOUR ADVANTAGES

Knob design for a modern, innovative image for your equipment.

Reliable operation with the tried and tested collet fixture system: convenient assembly of knobs from the front and tight fitting on the axis.

Without/with marking element.

For size 40 and larger, the cover is also available with a finger recess for rational handling during adjustment.

COMBINATION KNOBS

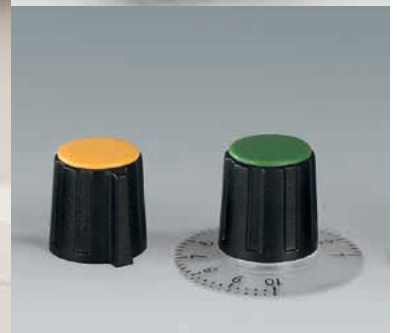

WELL ADJUSTED

THE PRODUCT

The name COMBINATION KNOBS stands for an exceedingly functional range of rotary buttons with a reliable collet fixture system.

They offer a versatile range of possible applications as round knobs, wing knobs and spindle-shaped knobs with a large selection of accessories.

YOUR ADVANTAGES

Tried and tested collet fixture system. Convenient assembly of knobs from the front, easy adjusting (by means of an adjusting key, see accessory). Tight fitting of knobs on the axis.

Round, wing and spindle-shaped knobs with the same standardized design and with matt surface.

A large variety of functional accessories, e.g. covers in different colors and transparent dials. Easy push-on assembly.

MATERIAL / COLOR

Knob:

- ABS (UL 94 HB), black (RAL 9005)
- ABS (UL 94 HB), dusty gray (RAL 7037)

Cover*

- ● ● ● ● ● ABS (UL 94 HB)

Arrow disk*

- ● ● ABS (UL 94 HB)

Disk*

- ABS (UL 94 HB)

Dial*

- PC (UL 94 HB)

Nut cover*

- ABS (UL 94 HB)
- ABS (UL 94 HB)

*depending on type / size



FUNCTIONAL DESIGN

DIM. IN MM

Ø 9, Ø 10, Ø 13.5, Ø 16, Ø 20, Ø 23,
Ø 31, Ø 40, Ø 50

FASTENING

Tried and tested collet system for rotary potentiometer with round shaft ends conforming to DIN 41591.

Sizes 10 and 13 have blind holes and screw fixing. From knob size 23 up through holes ① (sizes 16 + 20 stepped ②, except for axes 4 mm).

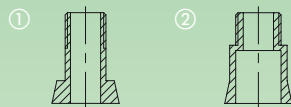

YOUR ADVANTAGES

Torsion protection for axes 6/4.6 mm available as accessory. Suitable for round and wing knobs sizes Ø 20 to 50 mm with 6 mm borehole.

We also produce our COMBINATION KNOBS in special colors, moq reserved. Please advise us of the color and quantity you require.

APPLICATIONS

Well proven for electro-mechanical rotary potentiometers with shaft ends corresponding to DIN 41591, e.g. within the field of measuring, controlling, regulating.



LARGE SELECTION OF TYPES

THE PRODUCT

The TUNING KNOB range covers many different fields of application.

Choose the TUNING KNOB whose size and design meets your own special requirements.

Thanks to the large selection of types, you have the opportunity of giving your equipment its own individual "face".

YOUR ADVANTAGES

For the varying applications involved we offer a range of tuning knobs in thermoplastic as well as knobs in thermosetting plastic for high temperature resistance (Duroplast).

Different designs and sizes – practical, with a good grip.

High-grade metal effects thanks to aluminum cap or insert embellisher. The color and styling of the front panel thus form a unified whole.

Versions with markings – advantageous for adjusting and indicating.

MATERIAL / COLOR

Knob:

- Thermoplastic, black
- Duroplastic, black

Embellisher cap, insert embellisher (depending on type):

- Aluminum

DIM. IN MM

from Ø 11.4 – Ø 38.9

FASTENING

With lateral screw fixing. Fastening A or B, depending on the knob type, see illustrations above or drawing in the Internet.



APPLICATIONS

“A MOVE AHEAD –
WITH OKW!”





CUSTOMER-SPECIFIC

"TAILOR-MADE
TO MEET YOUR
REQUIREMENTS."



INDIVIDUAL ENCLOSURE SOLUTIONS

MODIFIED STANDARD

Look at our comprehensive standard range and select the enclosure or tuning knob that matches your ideas, your components and the needs of your customer best.

In the next step you merely have to tell us what you still need for your own very personal product. Together with you we choose the necessary modifications from our wide range of services – ideal in terms of price, quality and delivery time – to meet your specific requirements.

Machining and finishing services see pages 124-131.

SPECIAL MATERIAL

Depending on requirements and intended use, we can produce the enclosures in special colors, in flame-resistant material or in an environment-friendly bio-plastic. See page 132.

SPECIAL SIZES

We can develop your customer-specific enclosure size on the basis of the standard design. With the help of existing 3D models, we can design practically any special size to meet your needs and requirements. See page 133.

BESPOKE ENCLOSURES AND TUNING KNOBS

And what if your requirements go beyond our standard services? No problem. 35 years of experience in the development of cases is waiting to help you realize your own individual solution.

From development to series-type production, we can offer you the solution you need, for any quantity.

See pages 134-137.



MECHANICAL MACHINING



Further information see our website www.okwenclosures.com



THE RIGHT RECESSES

MECHANICAL MACHINING

Individual machining, e.g. cutouts for interfaces, cable entries and outlets as well as cable bushes, displays and operating elements.

Milled parts for individual designs, e.g. inserts for interface devices, wall suspension elements etc.

Individual plastic and aluminum panels, e.g. covers, filter and safety screens for electronic displays, IR screens for infrared applications as well as front panels; blanks and finished parts according to customers' drawings.



Milling
Tapping
Drilling
Threading
Punching
Engraving



READY TO INSTALL

PLASTIC AND ALUMINUM

Mechanical processing of plastic and aluminum enclosure components.

State-of-the art machines guarantee high and uniform quality.

There is practically no limit to the variety of shapes and designs. You receive your enclosures ready for installation, and only have to mount the electronics.



Quality from a single source
Prototype and serial production

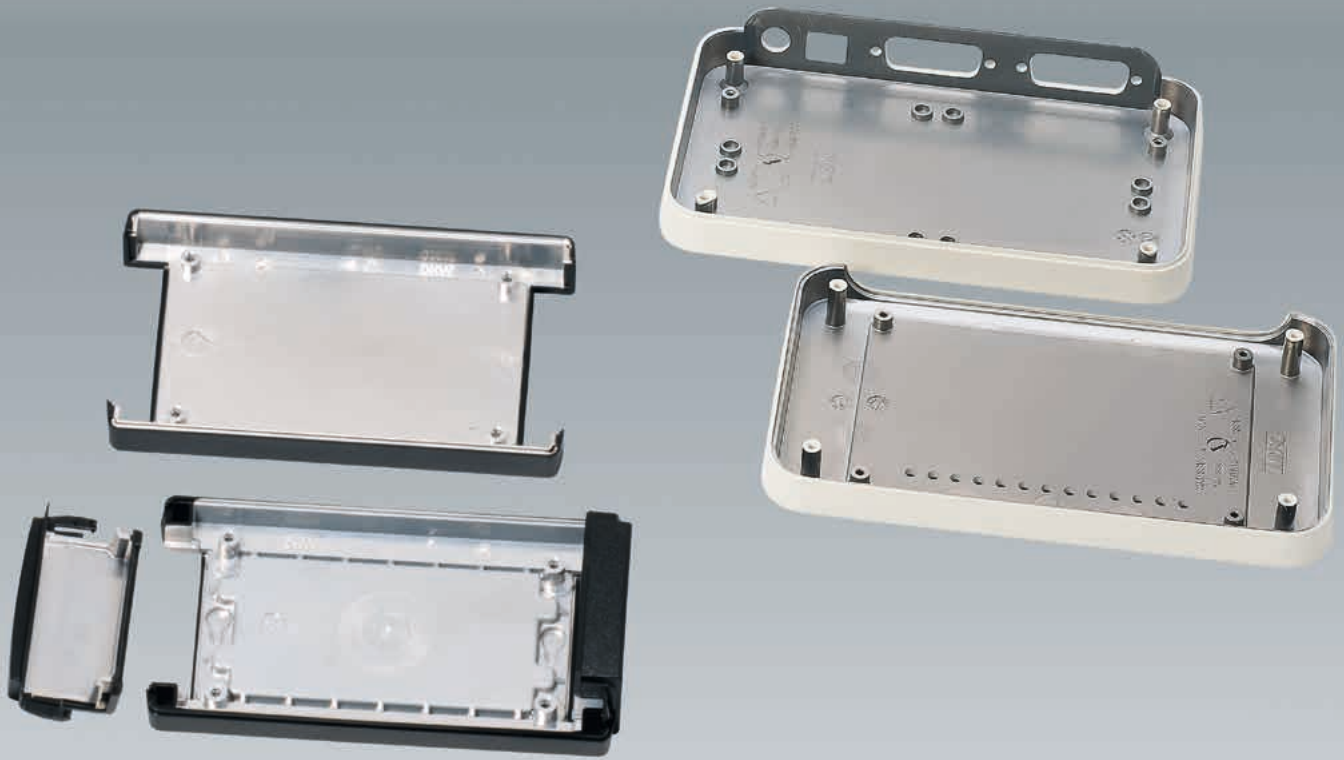

Further information see our website www.okwenclosures.com



PROTECTION FROM RFI/EMI

EMC ALUMINUM COATING

To shield electronic equipment against radiation from outside as well as from increased internal emission noise, we can vapor-plate with aluminum the inside of plastic enclosures and case parts that offer no natural protection from electromagnetic radiation.



Aluminum coating
Shielding effect with approx. 2.5 μm thickness: 30-40 dB in the frequency range from 30 to 1,000 MHz

EMC ACCESSORIES

IMPROVING CONTACTS

If required we can supply conductive seals in individual sizes as well as contact strips to improve the electromagnetic compatibility (EMC) of shielded enclosures.



Short production times thanks to in-house vapor-plating plant with numerous brackets and EMC accessories

Coating of other materials, individual coating thicknesses and EMC accessories on request.

SURFACE FINISHING



Further information see our website www.okwenclosures.com

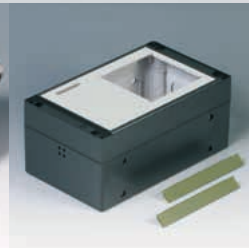
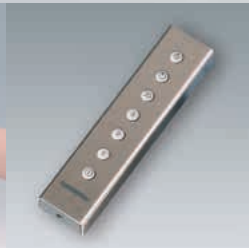

SAFETY IMPROVEMENT

PROTECTIVE LACQUER

Protective lacquers have proved valuable for special requirements.

ESD lacquer.

Antibacterial lacquer.

Protective lacquer against abrasion.

Special protective lacquer against unwanted marks from fingerprints.



Short preparation and processing times – all colors are made for you in our own mixing unit



Lacquering with high-grade, UV-resistant 2-component lacquers

Water transfer printing

Chromed

GREAT-LOOKING EFFECTS

FINISHING

Your enclosure and tuning knob in an individual color and unusual design.

Standard lacquers with different degrees of gloss, from matt to glossy.

Metallic colors.

Soft-Touch coating to improve the "feel" of your product.

Standard decals, see our website.



Further information see our website www.okwenclosures.com



INDIVIDUAL PRINTING

PRINTING

Depending on the required printed image and type of enclosure / tuning knob, we can offer you silk screen printing, tampo printing and digital printing.

Color definition in RAL, Pantone, NCS, according to sample or range of dyes. For digital printing CMYK.

Alternatively we can also engrave texts by machining, depending on the enclosure.



Screen printing
Tampo printing
Digital printing
Engraving



Personal touch thanks to individual lettering

INDIVIDUALITY

SPECIAL FEATURES

Precise multicolor printing.

All-round printing.

Printing with reflecting colors.

Printing day and night design elements for backlighting.

Text engraving, with and without color.

Digital printing directly on the case.

DIGITAL PRINTING, MEMBRANE KEYPAD



Further information see our website www.okwenclosures.com



PRINTING IN PHOTO QUALITY

DIGITAL PRINTING

The digital printing process (photo quality) allows different design versions without big expenses.

Decorative foils or banderoles can be printed even for just 1 unit for lettering and for adding color, and products can even be printed directly.

Special features: consecutive numbering, barcodes or price specifications.



Digital printing directly on the case also makes a great impression; we can print ABS surfaces with differences in height of up to 0.059"



KEYPAD TO CI STANDARDS

MEMBRANE KEYPAD

Use our potential for the production of your membrane keypads as well.

Through our cooperation with powerful partners, we are in a position to offer you a complete range, e.g. for remote controls, machine control systems, medical equipment (disinfected applications), electrical household appliances and peripheral equipment etc.



Keypad design without/with metal dome
Without/with integrated LEDs



Further information see our website www.okwenclosures.com



FULL ASSEMBLY OF THE DEVICE

ASSEMBLY

We will carry out mounting and assembling to complete your device e.g. mounting of cable glands and display windows, supply and mounting of threaded bushes or bolts, conductive gaskets, pocket belt, battery clips, membrane keypads or decorative foils.

Of course, you can also provide us with your own components or keypads for the assembly process.



If required we can support you in the development of the parts and components, and will help you plan suitable installation



HIGH-QUALITY PRESENTATION

SALES WRAPPING

Present your product in a high-quality sales wrapping!

On demand we create and print your individual sales wrapping or adhesive label in according to your corporate design rules.



Adhesive label
Banderole

INDIVIDUAL MATERIALS



Further information see our website www.okwenclosures.com



COLORS / PROPERTIES

SPECIAL PRODUCTION

For particular requirements to be met by the parts, such as improved chemical resistance, flame resistance or individual coloring, we can also produce standard enclosures in other materials and colors.

The online product catalog shows the possible special material options on the product pages.



Individual coloring
Flame-resistant materials



BIO plastic,
CO₂-neutral

SUSTAINABILITY

BIO PLASTIC

BIOGRADE® has similar properties to ABS and can be processed using the normal injection molding method. In many applications BIOGRADE® can replace the fossil plastics used up to now. For indoors applications there are no restrictions to the life cycle.

Show that you are responsible and environmentally aware with an enclosure made of BIOGRADE®.



Further information see our website www.okwenclosures.com

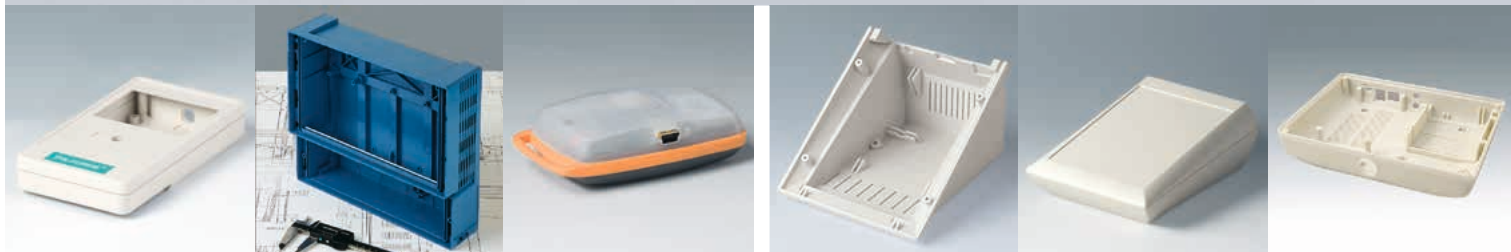

AN OKW ENCLOSURE MADE TO MEASURE

IN YOUR SIZE

SPECIAL SIZES

We can develop your customer-specific variant on the basis of the standard design.

With the help of existing 3D models, we can design practically any special size to meet your needs and requirements.

What installation volume do you need? We can adapt ...

- individual components, e.g. lower or higher top and bottom parts, or
- the size of the entire enclosure.



Individual size
Cutouts for interface panels can be integrated



Quality from the specialist
Aesthetic design

YOUR ADVANTAGES

Combination with standard parts.

With a special size, you can have your enclosure exactly adapted and produced to fit your electronics.

Rely on innovative technology by OKW and save valuable time in development.

Uniform design features – this is an advantage for your product portfolio when using different sizes and series of enclosures.

BESPOKE ENCLOSURES AND TUNING KNOBS



Combination of standard bottom part and customer-specific top part



DIN rail enclosure



Wall mount enclosure



Customer-specific top and bottom parts, standard battery compartment lid



Handheld enclosure



Control panel

YOUR IDEAS AND VISIONS REALIZED BY US

BESPOKE ENCLOSURES AND TUNING KNOBS

We are pleased to pass on to you our years of experience in the development and manufacture of plastic cases, for all the requirements to be met by a case which cannot always be implemented in one standard product. You should therefore make use of our potential for your individual case.

From development to series-type production, we can offer you the solution you need, for any quantity.

INDIVIDUAL DESIGN

We can create and develop exclusive designs for your products.

In this way, highly individual enclosures and tuning knobs geared to your application can be created in close cooperation with you.

We take account not only of the design but also of the material, the function and of course also your budget.

COMBINATION WITH STANDARD PARTS

Benefit from the combination with standard parts, e.g. the use of individual enclosure parts, battery compartment lids, battery clips etc.

In this way, your individual enclosure can be created within a short time and on reasonable terms.

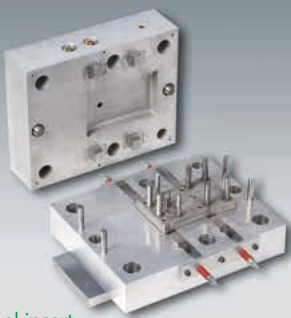

Tool insert



Customer-specific insert for interface device and wall suspension element



Handle – prototype and standard part using double injection technology



Protector made of TPE for ERGO-CASE M



New top part and optical fibers



Milled parts of aluminum/plastic



Additional illumination plate

TAILORED SOLUTIONS

MATERIAL MIX

PLASTIC & ALUMINUM

The materials of the enclosure can also be mixed. Plastic and aluminum. This creates a highly individual style and an interesting contrast. For example a front panel made of aluminum? Or the intermediate part? Without doubt, the visual effect can be improved by the interaction of the materials, and the mixture can cast a new light on the product.

HARD & SOFT

To place greater emphasis on ergonomic requirements, a material mix of *hard/soft* improves the touch and feel for the user. If required, customer-specific design of the injection tool or a combination with a function part.

ADDITIONAL FUNCTIONS

We develop and produce individual function parts to match your application. Here are some examples from our customers:

Optical fibers

Customer-specific optical fibers with a convex design to match the curve of the top part.

Charging cradle

Special attachment for depositing mobile devices. With a holder for the charging and data transfer contacts.

Enclosure inserts, attachments

For holding and contacting interface devices, installing scanners etc.

Wall mounting and desk-top display

Individual wall mounting and display, adjusted to the load-carrying capacity and the required angle of inclination.

Illumination plate

In a translucent design for the background lighting of the Star Knob operating element.

Handle

For holding, guiding and remotely controlling the device. Hard/soft using double injection technology.

And much more.

BESPOKE ENCLOSURES AND TUNING KNOBS



Hand-held device



Battery charger

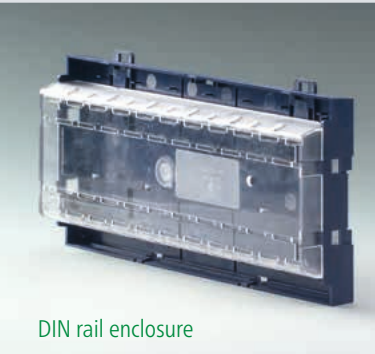

DIN rail enclosure



Scan attachment: prototype and standard part

CONCEPT & DEVELOPMENT

PROJECT PHASE 1

On the basis of your requirements profile, we can work out a conceptual solution to meet your product requirements.

Whether it is a question of product concept, material specifications, optimum tooling design, high quality surface finish etc., we have the technical competence for complete solution.



Individual consulting and development



From the idea to the first model

PROTOTYPING

PROJECT PHASE 2

Before implementing an individual case solution, we offer you the opportunity to create a prototype.

On the basis of the prototype, you can check integrated components, evaluate the design and in some cases even carry out functional tests.



Tool insert



Connection enclosure



DIN rail enclosure



Charging cradle



Covers



Electrical system

IMPLEMENTATION

PROJECT PHASE 3

After the design has been approved, we implement the concept by creating the molds, tool inserts and equipment.

Cost-effective solutions to meet your needs, for example the creation of interchangeable inserts in OKW's own standard molds, reduce your investment to the minimum.



Execution of the work through trained staff with the required knowledge

SERIAL PRODUCTION

PROJECT PHASE 4

For the series-type production of your individual enclosure / tuning knob solution, modern machine facilities are available.



Besides straight injection molding production, we can also finish your individual product in our Service Center



OUR WEBSITE - YOUR PORTAL

ONLINE PRODUCT CATALOGUE

Different search criteria support you in the selection of your products.

Choose ...

- by category: plastic enclosures, tuning knobs etc.
- by product application: hand-held enclosures, desk enclosures etc.
- by feature ("Advanced Search" link): dimensions, protection class, display type etc.

YOUR PERSONAL PRODUCT LIST



The website has a shopping basket icon. You can simply collect articles in your personal shortlist, compare different enclosure and tuning knob types with each other and draw up your own personal product list for online enquiries and requests for samples.

CHOOSE ACCESSORIES

On the relevant product pages we have listed a selection of suitable system components in the tab "Suitable System Components".

Adapted to the application, our standard enclosures can thus be modified in many different ways.

You can find universal accessories under "Plastic enclosures" > "Accessories for enclosures".

Enclosures

- ▶ Plastic enclosures
- ▶ Table-top / instrument enclosures
- Synergy
- Diatec
- Unitec
- Shell-Type Cases
- Motec
- Meditec
- Euro Case
- Lux Case
- Carrytec

Samples & Quotes

Get your samples! Simply click on the basket symbol to add items to your personal list. You can then request samples and get a quotation. Learn more here

Contact us

Your partner USA & Canada
 OKW Enclosures Inc.
 Bridgeville PA 15017
 Tel. (800) 965-9872
 eMail inquiry

You are here: Enclosures ▶ Plastic enclosures ▶ Table-top / instrument enclosures ▶ Synergy ▶ E0163059

E0163059

SYNERGY 0160

4-part enclosure for many different applications. Sturdy frame made of aluminum, glass bead-blasted and anodized. Plastic parts made of ASA+PC-FR with good UV resistance and high flame resistance. Attachment domes for PCBs and components in the top and bottom parts. Top part with recessed surface to protect the membrane keyboard. Bottom part with opening and screw-down cover: practical for the use of a battery compartment or for access to the interior, e.g. for a memory card or batteries that are mounted directly on the PCB. Battery compartment kit 3 x AA with contact springs, battery clips, button cell holder and wall mounting option as accessories.

Supply

Top part, bottom part, lid, aluminum profile, assembly kit

Technical Data	Drawings / Further Information	Purchasing Data
Material	Aluminum AlMgSi 0.5 Frame ASA+PC-FR (UL 94 V-0) Plastic parts	Length 6.299" 160 mm Width 3.150" 80 mm Height 1.575" 40 mm PCB length, base 5.882" 149.4 mm PCB length, top 5.882" 149.4 mm PCB width, base 2.535" 64.4 mm PCB width, top 2.535" 64.4 mm Keypad length 5.594" 142.1 mm Keypad width 2.445" 62.1 mm
Protection class	IP 40	
Color	Frame matt anodized, Plastic parts black RAL 9005	
Standards	RoHS compliant REACH compliant	

Suitable System Components

View Customizing Options

NEW PRODUCT View

Accessory "battery"

Accessory "wall/holder"



Enclosures

- Plastic enclosures
- Table-top / Instrument enclosures
- Synergy
- Diatec
- Unitec
- Shell-Type Cases
- Motec
- Medtec
- Euro Case
- Lux Case
- Carrytec

Samples & Quotes

Get your samples
Simply click on the basket symbol to add items to your personal list. You can then request samples and get a quotation. Learn more here

Contact us

Your partner USA & Canada
OKW Enclosures Inc.
Bridgeville PA 15017

Tel. (800) 965-9872
eMail inquiry

You are here: Enclosures » Plastic enclosures » Table-top / Instrument enclosures » Synergy » EO163059



EO163059

SYNERGY O160

4-part enclosure for many different applications. Sturdy frame made of aluminum, glass bead-blasted and anodized. Plastic parts made of ASA+PC-FR with good UV resistance and high flame resistance. Attachment domes for PCBs and components in the top and bottom parts. Top part with recessed surface to protect the membrane keyboard. Bottom part with opening and screw-down cover: practical for the use of a battery compartment or for access to the interior, e.g. for a memory card or batteries that are mounted directly on the PCB. Battery compartment kit 3 x AA with contact springs, battery clips, button cell holder and wall mounting option as accessories.

Supply

Top part, bottom part, lid, aluminum profile, assembly kit

Technical Data	Drawings / Further Information	Purchasing Data		
Material	Aluminum AlMgSi 0.5	Length	6.299"	160 mm
	Frame	Width	3.150"	80 mm
	ASA+PC-FR (UL 94 V-0)	Height	1.575"	40 mm
Protection class	Plastic parts	PCB length, base	5.882"	149.4 mm
	IP 40	PCB width, base	2.535"	64.4 mm
Color	Frame matt anodized, Plastic parts black RAL 9005	PCB length, top	6.063"	154 mm
		PCB width, top	2.535"	64.4 mm
Standards	RoHS compliant REACH compliant	Keypad length	5.594"	142.1 mm
		Keypad width	2.445"	62.1 mm

Suitable System Components

View Customizing Options

Customizing options for EO163059

What else do you need to create your own personal product? We can supply our enclosures and tuning knobs fully modified to suit your electronic components and design requirements. Select the customizing option(s) you need from the list below. Then click on "Add product and customizing option to my list", complete your specifications and contact details, and hit "submit" to receive a written quotation.

- Select
- Processing and Finishing
 - Rapid Prototyping
 - RF/EMI Aluminium coating
 - Machining
 - Lacquering
 - Water transfer printing
 - Screen/tampo printing
 - Digital printing labels
 - Digital printing parts
 - Membrane keyboards
 - Installation / Assembly of accessories
 - Display window
 - Adhesive foils
 - Plastic and aluminum panels
 - Special Material
 - Special material "individual colors"
 - Custom Design
 - Bespoke enclosures and tuning knobs

Add product and customizing option(s) to my list >>>

- Customizing options
- 2D PDF Drawing (Acrobat Reader)
- 3D PDF View (Acrobat Reader)
- Add to my list

EO163059

SYNERGY O160

4-part enclosure for many different applications. Sturdy frame made of aluminum, glass bead-blasted and anodized. Plastic parts made of ASA+PC-FR with good UV resistance and high flame resistance. Attachment domes for PCBs and components in the top and bottom parts. Top part with recessed surface to protect the membrane keyboard. Bottom part with opening and screw-down cover: practical for the use of a battery compartment or for access to the interior, e.g. for a memory card or batteries that are mounted directly on the PCB. Battery compartment kit 3 x AA with contact springs, battery clips, button cell holder and wall mounting option as accessories.

Supply

Top part, bottom part, lid, aluminum profile, assembly kit

Technical Data	Drawings / Further Information	Purchasing Data
----------------	--------------------------------	-----------------

Catalog Pages

- SYNERGY in inches, leaflet 1,288 KB
- SYNERGY in mm, leaflet 2,336 KB

Drawings

- PDF-File (without registration) 320 KB
- AutoCAD DWG-File 843 KB
- AutoCAD DXF-File 3,190 KB
- 3D PDF View (Acrobat Reader) (turn the product 360°, blind components out for inside view...) 7,614 KB

3D-Models

- 00015618.x_t 4,780 KB
- 00015618.step 11,322 KB
- 00015618.sat 17,330 KB

Miscellaneous information

- screws for enclosures 62 KB
- self-tapping screws for PCB mounting 41 KB

Login to VIP-Lounge

Welcome to the VIP-Lounge Login.

E-Mail

Password

Forgot your password?

Login

User registration

If you don't already have a login, please register. With the login you will be able to download CAD drawings and 3D models for each part. OKW website registration process. Learn more here.

Go to registration.

INFORMATION AT THE CLICK OF A MOUSE

SELECTING AND ADDING SERVICES

On the relevant product pages you can also see the matching customizing options. Select the modifications and finishes you want and add these, together with the product, to your product list! Then specify your requirements and add your contact details to complete and send off your online enquiry. We shall be pleased to submit a quotation.

DOWNLOAD GEOMETRIC DATA

Geometric product data can be downloaded from our website **on the product pages**.

Drawings in PDF format (2D/3D) are available for your own use.

You can download other 3D geometric data after you have registered, activated your account and agreed to the terms of use.

OKW WEBSITES WORLDWIDE

Global	www.okw.com
Australia	www.okw.com.au
France	www.okw.fr
Russia	www.okw.com.ru
Switzerland	www.okw.ch
U.K.	www.okw.co.uk
U.S.A.	www.okwenclosures.com

OKW

GEHÄUSE SYSTEME

www.okwenclosures.com

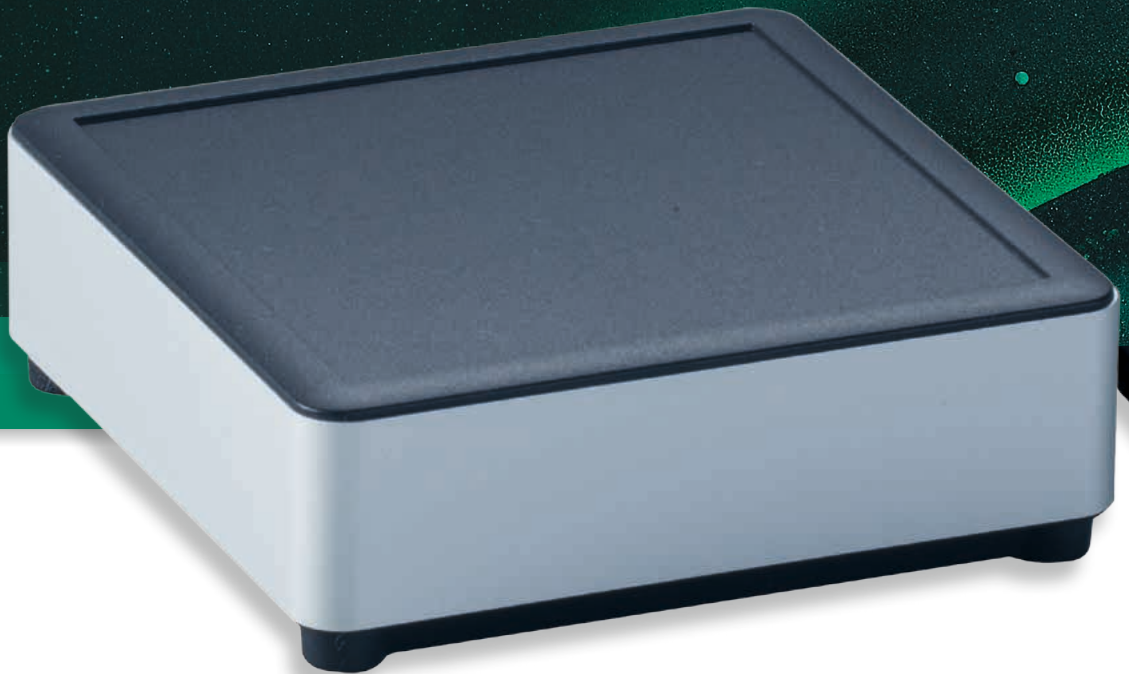

Presented by:

OKW
OKW ENCLOSURES, INC

OKW Enclosures Inc.
3000 Old Pond Road
Bridgeville PA 15017
U.S.A.

Toll Free (800) 9 65 98 72

Fax (412) 220-9247

E-Mail sales@okwenclosures.com

Web www.okwenclosures.com



Turtle © by OKW Gehäusesysteme, Buchen. This catalog will be valid until the new catalog is issued, latest 31.12.2018.
Subject to technical modification without notice. Typographical and other errors do not justify any claim for damages. DP2016us. 03.2016us

Manufacturer

Odenwälder Kunststoffwerke
Gehäusesysteme GmbH
Friedrich-List-Str. 3
74722 Buchen/Germany

+49 (0) 62 81 / 4 04-00
+49 (0) 62 81 / 4 04-144
Info@okw.com
www.okw.com